

**Citroën C5 Aircross** 01/2019 >>  
**DS7 Crossback** 02/2018 >>  
**Opel Grandland X** 10/2017 >>  
**Peugeot 3008** 10/2016 >>  
**Peugeot 5008** 03/2017 >>

Partnr.: PE-084-D1

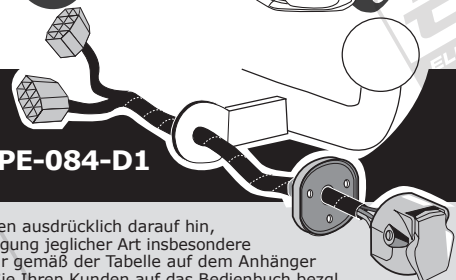

**DE** • Einbauanleitung Elektrosatz Anhängervorrichtung mit 13-P Steckdose lt. DIN/ISO Norm 11446. • Wir weisen ausdrücklich darauf hin, dass eine unsachgemäße und nicht in einer Fachwerkstatt durchgeführte Montage einen Verzicht auf Entschädigung jeglicher Art insbesondere bezüglich des Produkthaftpflichtrechts zur Folge hat. • Technische Änderungen vorbehalten. • Widerstand nur gemäß der Tabelle auf dem Anhänger verwenden. • Achtung! Bitte lesen Sie vorab diese Anleitung, nehmen Sie diese zur Kenntnis und verweisen Sie Ihren Kunden auf das Bedienbuch bezgl. der eventuell zu treffenden Maßnahmen zum Ziehen eines Anhängers. • Bei Funktionsproblemen ist die Fehlersuche auf ca. 0,5 Stunden zu begrenzen, kontaktieren Sie die ECS Technical Support: ts@ecs-electronics.nl / 00800 22552327

**FR** • Instructions de montage du faisceau électrique pour crochet d'attelage conforme à la norme DIN/ISO 11446 prise 13-P. • Il est expressément prévu qu'il ne saurait se prévaloir d'un quelconque préjudice contractuel ou réhibitoire si le montage avait été fait en dépit des dites instructions ou dans un garage ne disposant pas des équipements adéquats. • Sous réserve de modifications techniques. • Ne excédez pas la charge maximale, indiquée dans le tableau. • Attention! Avant de commencer le branchement, on vous prie de prendre compte des connexions à faire dans la notice, ainsi que communiquer directement à votre client les mesures à prendre pour tirer une remorque. • S'il y a des problèmes de fonctionnement, limiter la recherche de défauts à env. 30 minutes et contacter ECS l'Aide en ligne: ts@ecs-electronics.nl / 00800 22 55 23 27.

**NL** • Montage-handleiding elektrokabelset voor trekhaak met 13-P contactdoos vlg. DIN/ISO norm 11446. • Wij wijzen er met nadruk op, dat ondeskundige en niet door een vakkundige werkplaats uitgevoerde montage tot gevolg heeft dat daardoor ieder recht op schadevergoeding, ook op wettelijke aansprakelijkheid inzake producten, vervalt. • Technische wijzigingen voorbehouden. • Gebruik alleen belasting volgens aansluittabel op het getrokken voertuig. • Opgelet! Wij verzoeken U dringend vooraf deze instructie door te nemen, hiervan kennis te nemen en uw cliënt te verwijzen naar het instructieboekje betreffende de eventueel te nemen maatregelen voor het trekken van een aanhangwagen. • Bij werkingsproblemen moet de foutencontrole tot ca. 0,5 uur beperkt worden, neem contact op met de ECS Technical Support: ts@ecs-electronics.nl / 00800 22 55 23 27.

**GB** • Fitting instructions electric wiring kit tow bar with 13-P socket up to DIN/ISO Norm 11446. • We would expressly point out that assembly not carried out properly by a competent installer will result in cancellation of any right to damage compensation, in particular those arising by virtue of the product liability act. • Contents of these kits and their fitting manuals are subject to alteration without notice, please ensure that these instructions are read and fully understood before commencing installation. • Do not overload circuits; the maximum loads per connection are detailed in this manual. • Attention! Before installation, please read this manual carefully and inform your customer to consult the vehicle owners manual to check for any vehicle modifications required before towing. • In the event of functional problems, troubleshooting must be limited to about 0.5 hours, contact the ECS Technical Support: ts@ecs-electronics.nl / 00800 22 55 23 27.

**ES** • Instrucciones de montaje de kit eléctrico para enganche de remolque con caja de conexiones 13-P según norma DIN/ISO 11446. • El montaje inapropiado y efectuado por personal no cualificado originará la pérdida de todo derecho a indemnización o la expiración de toda responsabilidad civil con respecto al producto. • Nos reservamos el derecho a efectuar modificaciones técnicas. • Utilice sólo cargas de acuerdo a la tabla de conexión del vehículo remolcado. • Atención: lea atentamente este manual antes de la instalación e informe al cliente que debe consultar el manual de usuario del vehículo para conocer cualquier modificación realizada. • En caso de tener problemas con su funcionamiento, la búsqueda de errores está limitada a aprox. 0,5 horas, por lo que le recomendamos ponerse en contacto con el servicio de atención telefónica: ts@ecs-electronics.nl / 00800 22 55 23 27.

**IT** • Istruzioni di montaggio di set di cavi elettrici per gancio da traino con zoccolo a 13-P conforme alla norma DIN/ISO 11446. • Sottolineiamo espressamente che un montaggio inadeguato ed eseguito da un'officina non specializzata ha come conseguenza il decadere di qualsiasi diritto al risarcimento danni, nonché alla responsabilità legale relativa ai prodotti. • Ci si riserva il diritto di apportare modifiche tecniche. • Utilizzare esclusivamente un carico conforme alla tabella degli allacci relativa al veicolo in questione. • Attenzione! Vi invitiamo a leggere attentamente questo manuale e a invitare a vostra volta i clienti a leggere il manuale del conducente sulle eventuali misure da prendere per l'attacco di un rimorchio. • In caso di problemi di funzionamento, la ricerca di errori dovrebbe essere limitata a circa 0,5 ore. Contattare il centralino di assistenza per i fasci di cavi: ts@ecs-electronics.nl / 00800 22 55 23 27.

**SE** • Monteringsanvisningar elkabelsats för dragkrok med 13-P kontaktdosa enligt DIN/ISO norm 11446. • Vi påpekar med eftertryck att all rätt till skadeersättning och all laglig ansvarighet förfaller om monteringen inte har utförts på rätt sätt och av en professionell verkstad. • Tekniska ändringar förbehålles. • Använd endast belastning enligt anslutningstabellen på det dragna fordonet. • Varning! Innan installation, läs den här handboken noga och informera din kund om att läsa fordonets användarhandbok för att undersöka vilka eventuella ändringar som behöver göras på fordonet. • Vid funtionsproblem ska felsökningen begränsas till ca 0,5 timme, kontakta reservdels-helpline ts@ecs-electronics.nl / 00800 22 55 23 27.

**CZ** • Montážní pokyny: souprava pro elektrické propojení tažné tyče s 13-P zásuvkou do normy DIN/ISO 11446. • Výslovně zdůrazňujeme, že jakákoli montáž, která není provedená ve specializované dílně, má za následek odvolání nároků na kompenzaci jakéhokoli druhu, obzvláště vyplývajících ze zákona o odpovědnosti za způsobené škody. • Změny mohou být provedeny bez oznámení. • Použijte pouze při maximálním nabití podle tabulky na tažném vozidle. • Upozornění! Prosíme, abyste si nejdříve přečetli tyto instrukce, seznámili se s nimi a odkázali své zákazníky na příručku týkající se případných opatření, která musí být přijata pro tažení přívěsu. • Při problémech funkčnosti je třeba vyhledávání chyb omezit na cca 0,5 hodiny, kontaktujte ECS Technical Support: ts@ecs-electronics.nl / 00800 22 55 23 27.

**DK** • Monteringsvejledninger for det elektriske ledningsføringssæt for trækstang med 13-P stikdåse, DIN/ISO, norm 11446. • Vi ønsker at gøre udtrykkeligt opmærksom på atforkert samling, der ikke er udført af et specialiseret værksted, resulterer i bortfaldelse af kompenseringsskrav af alle slags, i særdeles krav der måtte opstå omkring det lovligtige ansvar. • Kan ændres uden varsel. • Brug kun den maksimale belastning, i overensstemmelse med forbindelsestabelen for bugserede køretøjer. • OBS! For installation skal denne vejledning læses omhyggeligt og din kunde skal informeres om at kigge i køretøjets håndbog for at kontrollere om der skal laves eventuelle ændringer på køretøjet inden bugsering. • Ved funktionsproblemer skal fejlsøgningen begrænses til ca. 0,5 time, kontakt ECS Technical Support: ts@ecs-electronics.nl / 00800 22 55 23 27.

**FI** • Ohjeet vetokoukun sähkökaapelisarjan asentamiseen, jossa on DIN/ISO 11446 mukainen 13-P liitin. • Korostamme, että kaikki oikeudet vahinkokorvaukseen kuten myös valmistajan laillinen vastuu raukeavat, mikäli asennusta ei ole toteutettu oikealla tavalla eikä ammattitaitoisen asiantuntijan toimesta. • Oikeus teknisiin muutoksiin ilman erillistä huomautusta pidätetään. • Huomio! Lue tämä käyttöoppas huolellisesti ennen asennusta ja tiedota asiakkaita tarkistamaan kaikki ajoneuvon muutoksen ajoneuvon omistajan käyttöoppaas ennen hinausta. • Kuormita työvirtapiiriä ainoastaan hinattavan ajoneuvon kytkentäkaavin mukaisesti. • Virhehaku on rajoitettava toiminto-ongelmien esiintyessä noin 0,5 tuntiin, ota yhteys ECS Technical Support: ts@ecs-electronics.nl / 00800 22 55 23 27.

**GR** • Οδηγίες συναρμολόγησης ηλεκτρικού σετ καλωδίων μπάρας ρυμούλκησης με υποδοχή 13-P μέχρι DIN/ISO Κανόνας 11446. • Επισημαίνουμε κατηγορηματικά ότι οποιαδήποτε εσφαλμένη συναρμολόγηση, η οποία δεν έχει πραγματοποιηθεί ειδικό εργαστήριο θα οδηγήσει σε αποποίηση των αξιώσεων επιβολής αποζημιώσεων οποιασδήποτε είδους, ειδικά όσα προκύπτουν από το νόμο ευθύνης προϊόντων. • Μπορεί να τροποποιηθεί χωρίς προηγούμενη ειδοποίηση. • Χρησιμοποιείτε μόνο μέγιστο ηλεκτρικό φορτίο σύμφωνα με τον πίνακα σύνδεσης στο ρυμούλκούμενο όχημα. • Προσοχή! Πριν την εγκατάσταση, διαβάστε το εγχειρίδιο αυτό προσεκτικά και ενημερώστε τον πελάτη σας να συμβουλευτεί το εγχειρίδιο ιδιοκτητών οχήματος ώστε να ελεγχθεί τυχόν τροποποιήσεις που απαιτούνται στο όχημα πριν τη ρυμούλκηση. • Σε περίπτωση προβλημάτων λειτουργίας να περιοριστεί η αναζήτηση σφαλμάτων σε περί. 0,5 δευτ., επικοινωνήστε με τη γραμμή υποστήριξης ECS Technical Support: ts@ecs-electronics.nl / 00800 22 55 23 27.

**NO** • Monteringsanviser elkabelsett for trekkrok med 13-P koblingsboks ifølge DIN/ISO norm 11446. • Vi påpeker ettertrykkelig at all rett til skadeerstatning og rettslig ansvar forfaller dersom monteringen ikke er blitt utført på riktig måte og av et profesjonelt verksted. • Tekniske endringer forbeholdes. • Overskrid ikke grensene anviset i tilkoblingstabellen på tilhengeren eller det tilkoblede kjøretøyet. • OBS! Les denne bruksanvisningen nøye før installasjon. Be kunden om å rådføre seg med brukerhåndboken for kjøretøyeiere for å sjekke om kjøretøyet må modifiseres før tauing. • Ved funksjonsproblemer må feilsøket begrenses til ca. 0,5 timer, kontakt ECS Technical Support: ts@ecs-electronics.nl / 00800 22 55 23 27.

**PL** • Instrukcje montażu zestawu okablowania elektrycznego dysza holowniczego z 13-P stykowym gniazdem DIN/ISO 11446. • Chcielibyśmy wyraźnie zaznaczyć, iż wszelki nieprawidłowy montaż, który nie jest wykonywany w specjalistycznym warsztacie pociąga za sobą utratę możliwości dochodzenia wszelkiego typu roszczeń, w szczególności tych wynikających z odpowiedzialności producenta za swój produkt. • Podlega zmianom bez powiadomienia. • Używać tylko takiego maksymalnego obciążenia, które wynika z tabliczki połączeń holowanego pojazdu. • Uwaga! Przed zainstalowaniem należy dokładnie przeczytać te instrukcje i poinformować klienta o konieczności sprawdzenia w instrukcji posiadacza pojazdu w celu sprawdzenia przed holowaniem, czy nie wprowadzono do pojazdu jakichkolwiek zmian. • W przypadku problemów ograniczyć wyszukiwanie błędów do ok. 0,5 godziny, skontaktować się z linią serwisową ts@ecs-electronics.nl / 00800 22 55 23 27.

DE Einzelteilliste

FR Liste de pieces

NL Onderdelenlijst

GB Part list

ES Lista de componentes

IT Elenco componenti

SE Dellista

CZ Seznam dílů

DK Del-liste

FI Osaluettelo

GR Κατάλογος εξαρτημάτων

NO Delliste

PL Lista części

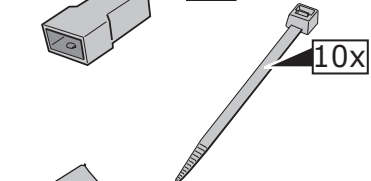
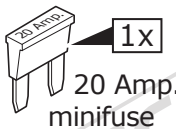
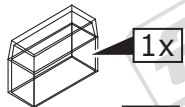
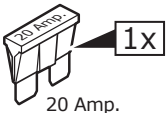
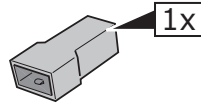
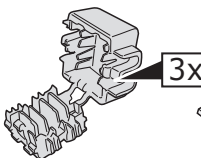
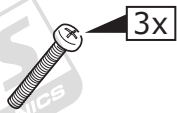
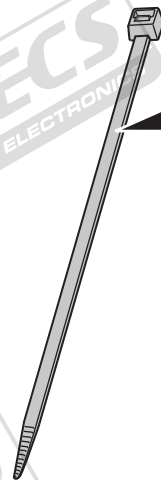
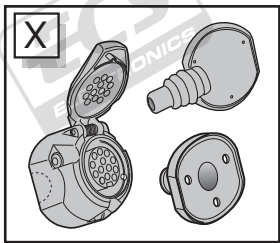
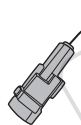
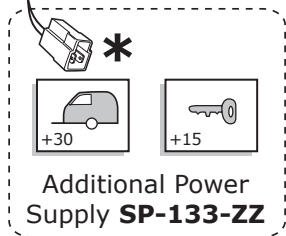
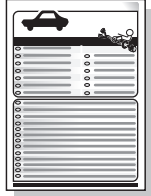
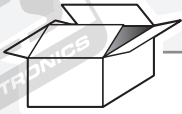

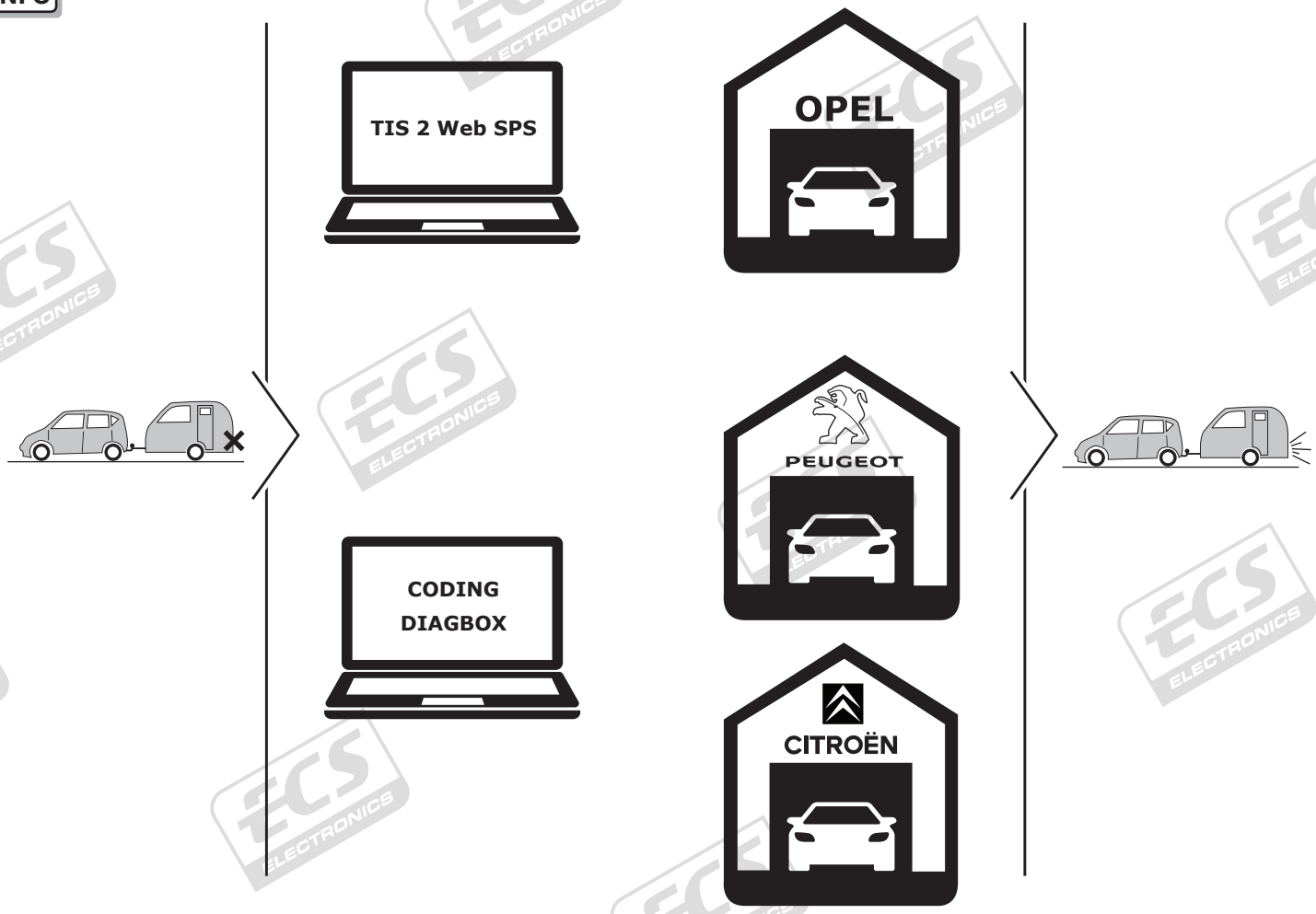

- Ⓓ Fahrzeug codieren für Beleuchtungsfunktionen
- Ⓕ Coder le vehicule pour les fonctions d'éclairage
- Ⓖ Voertuig coderen voor verlichtingsfuncties
- Ⓖ Code vehicle for lighting functions
- Ⓔ Codificar el vehículo para que funcione las luces
- Ⓘ Codificare il veicolo per le funzioni di illuminazione
- Ⓐ Registrera dig för belysningsfunktioner
- Ⓒ Zaregistrujte se funkce osvětlení
- Ⓓ Tilmeld dig lysfunktioner
- Ⓕ Ilmoittaudu valaistustoimintojen
- Ⓖ Εγγραφείτε για τις λειτουργίες φωτισμού
- Ⓖ Abonner på lysfunksjoner
- Ⓐ Zarejestruj się w funkcji oświetlenia

**INFO**

	BK	BN	BU	GY	GN	WH	YE	OG	PE	PI	RD	NL	BG
DE	Schwarz	Braun	Blau	Grau	Grün	Weiß	Gelb	Orange	Violett	Rosa	Rot	Naturfarben	Beige
FR	Noir	Marron	Bleu	Gris	Vert	Blanc	Jaune	Orange	Violet	Rose	Rouge	Nature	Beige
NL	Zwart	Bruin	Blauw	Grijs	Groen	Wit	Geel	Oranje	Paars	Roze	Rood	Naturel	Beige
GB	Black	Brown	Blue	Grey	Green	White	Yellow	Orange	Purple	Pink	Red	Natural colour	Beige
ES	Negro	Marrón	Azul	Gris	Verde	Blanco	Amarillo	Naranja	Morado	Rosa	Rojo	Color natural	Beige
IT	Nero	Marrone	Blu	Grigio	Verde	Bianco	Giallo	Arancione	Viola	Rosa	Rosso	Colori naturali	Beige
SE	Svart	Brun	Blå	Grå	Grön	Vit	Gul	Orange	Lila	Rosa	Röd	Naturfärger	Beige
CZ	Černá	Hnědá	Modrá	Šedá	Zelená	Bílá	Žlutá	Oranžová	Fialová	Růžová	Červená	Přírodní	Béžový
DK	Sort	Brun	Blå	Grå	Grøn	Hvid	Gul	Orange	Lilla	Pink	Rød	Naturfarvet	Beige
FI	Musta	Ruskea	Sininen	Harmaa	Vihreä	Valkoinen	Keltainen	Oranssi	Purppura	Vaaleanpunainen	Punainen	Luonnonväri	Beige
GR	Μαύο	Καφέ	Μπλε	Γκρι	Πράσινο	Λευκό	Κίτρινο	Πορτοκαλί	Μοβ	Ροζ	Κόκκινο	Φυσικά χρώματα	μπεζ
NO	Svart	Brun	Blå	Grå	Grønn	Hvit	Gul	Oransje	Lilla	Rosa	Rød	Naturfarger	Beige
PL	Czarny	Brazowy	Niebieski	Szary	Zielony	Biały	Żółty	Pomarańczowy	Purpurowy	Różowy	Czerwony	Barwy	beżowy

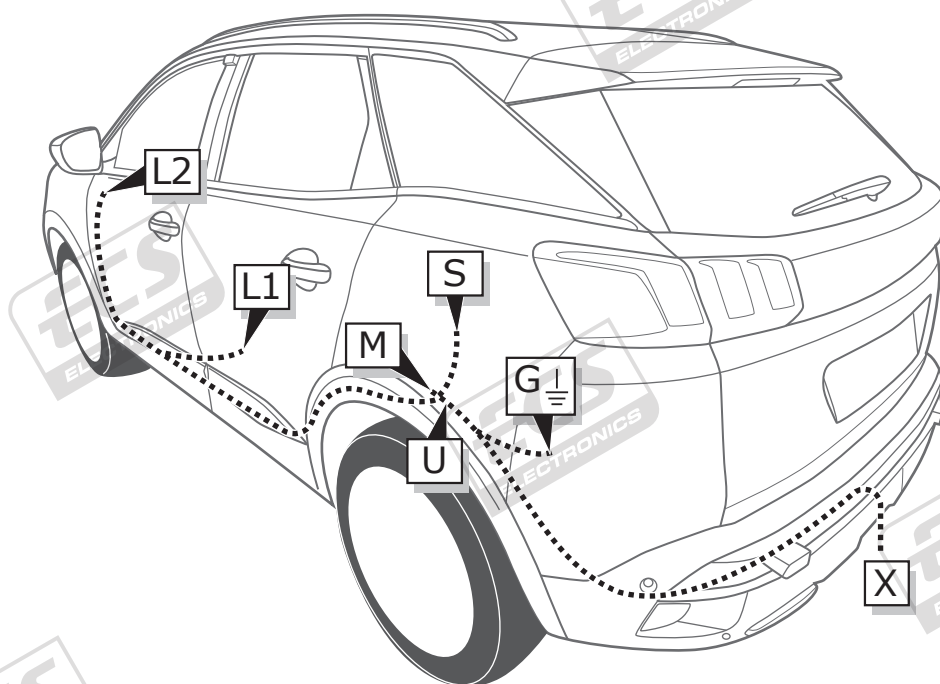
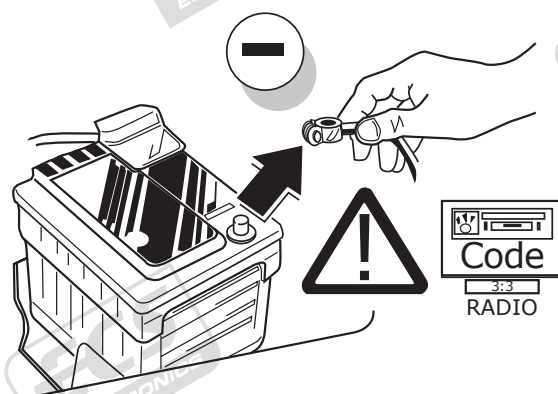
**ROUTING**

**1**

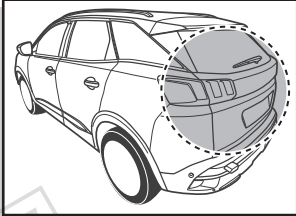
2



3008

Grandland X

C5 Aircross

DS7 Crossback

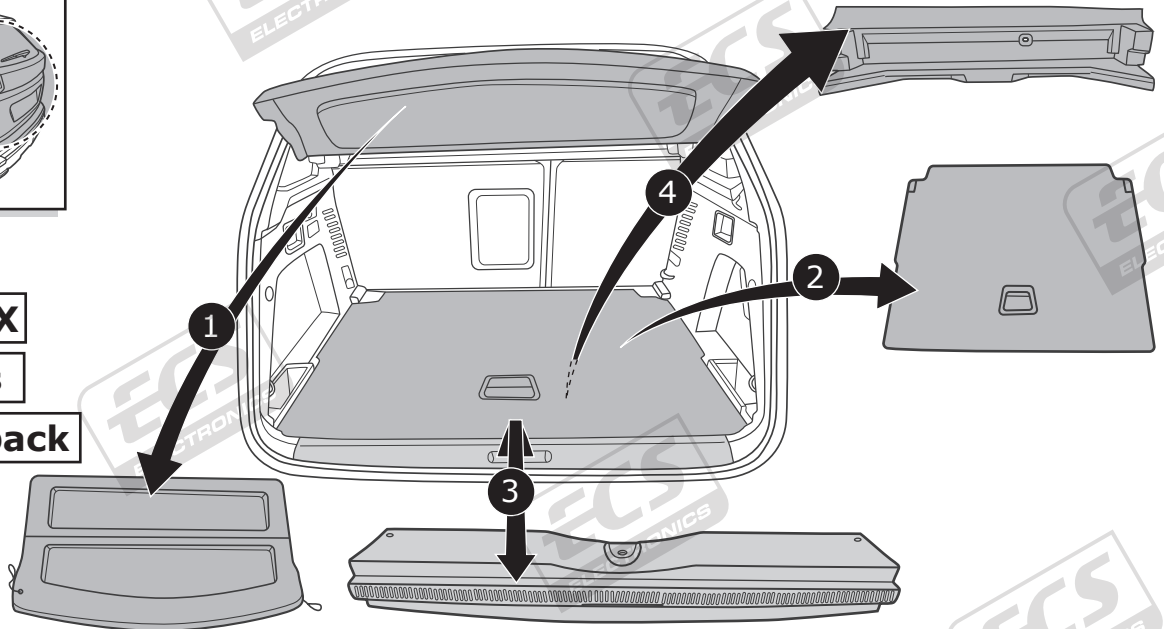

3

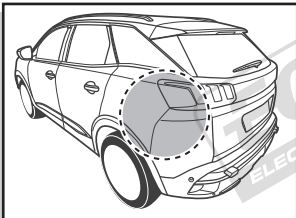

3008

Grandland X

C5 Aircross

DS7 Crossback

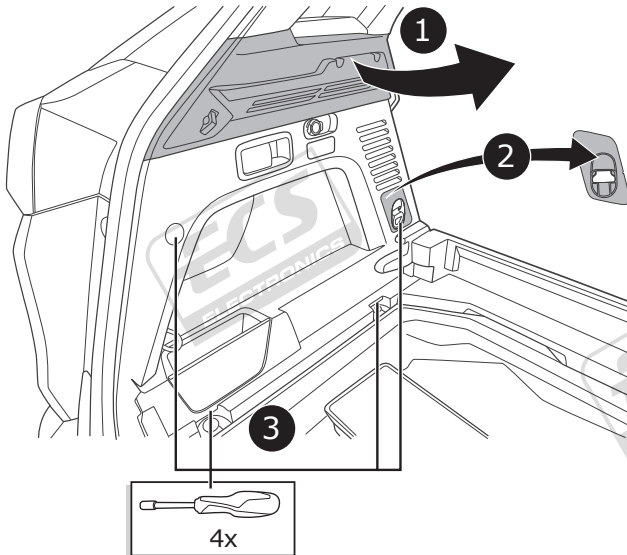

4

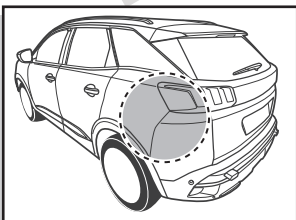

3008

Grandland X

C5 Aircross

DS7 Crossback

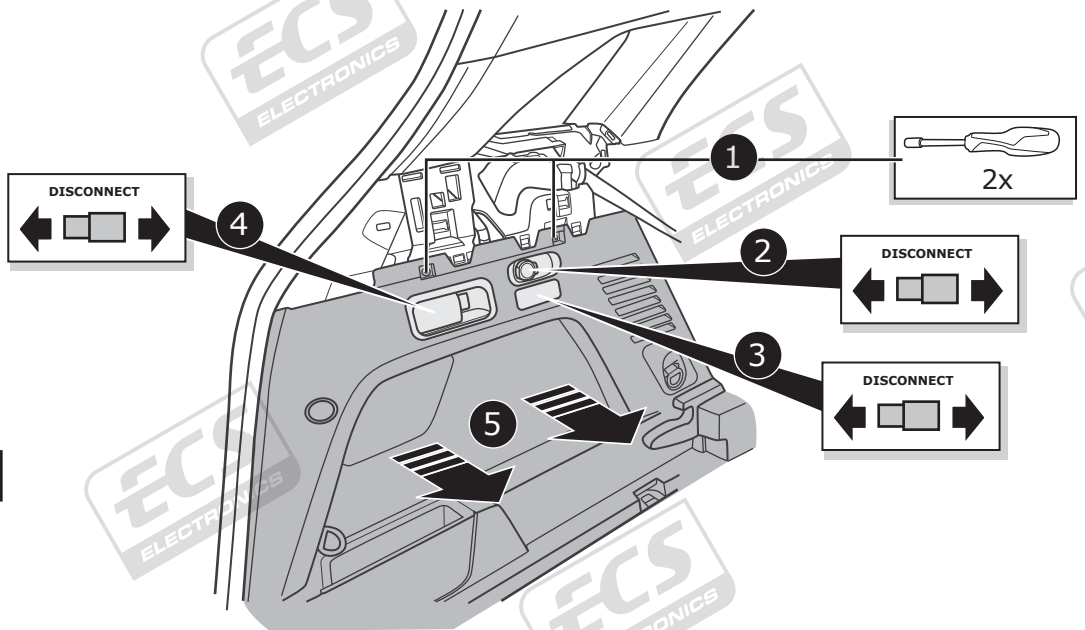

5

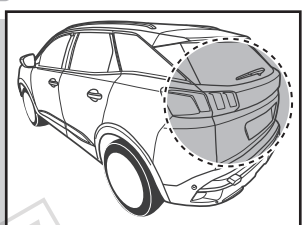

5008

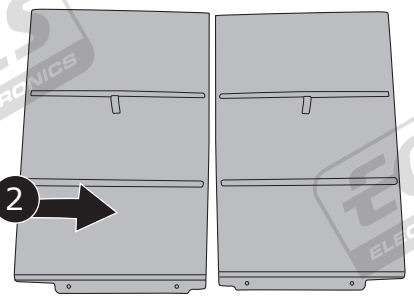
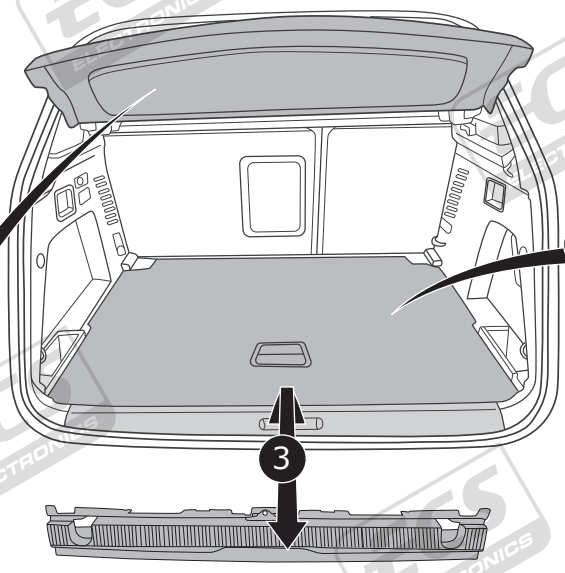
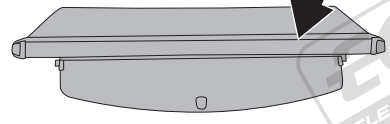

6

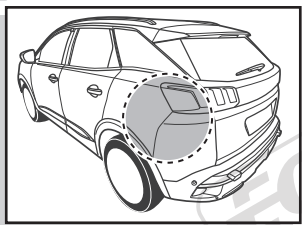

5008

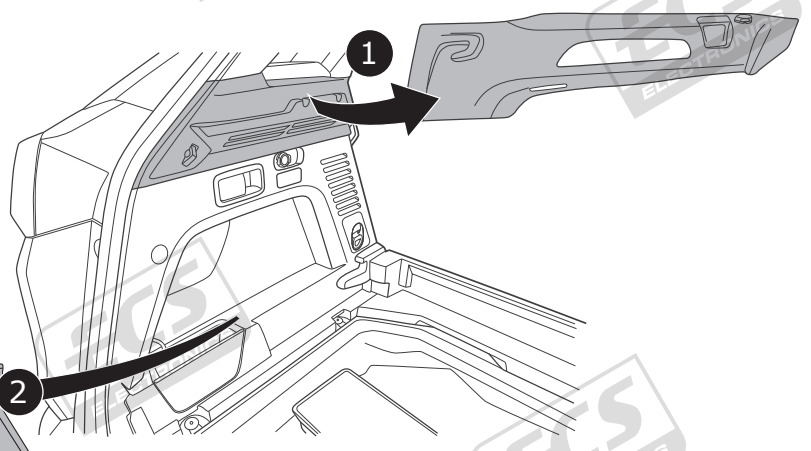
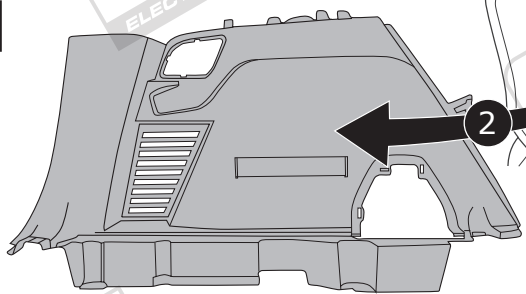

7

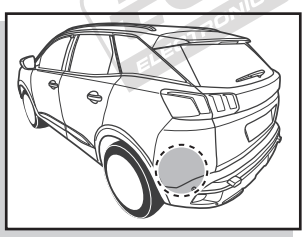

SEAL WITH SILICONE.

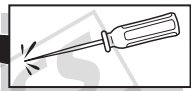
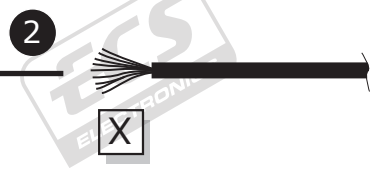
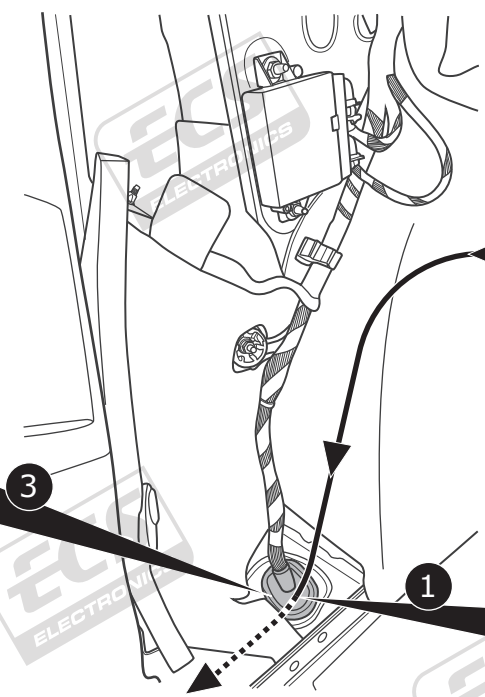
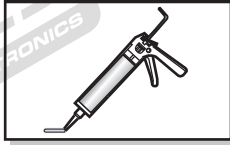

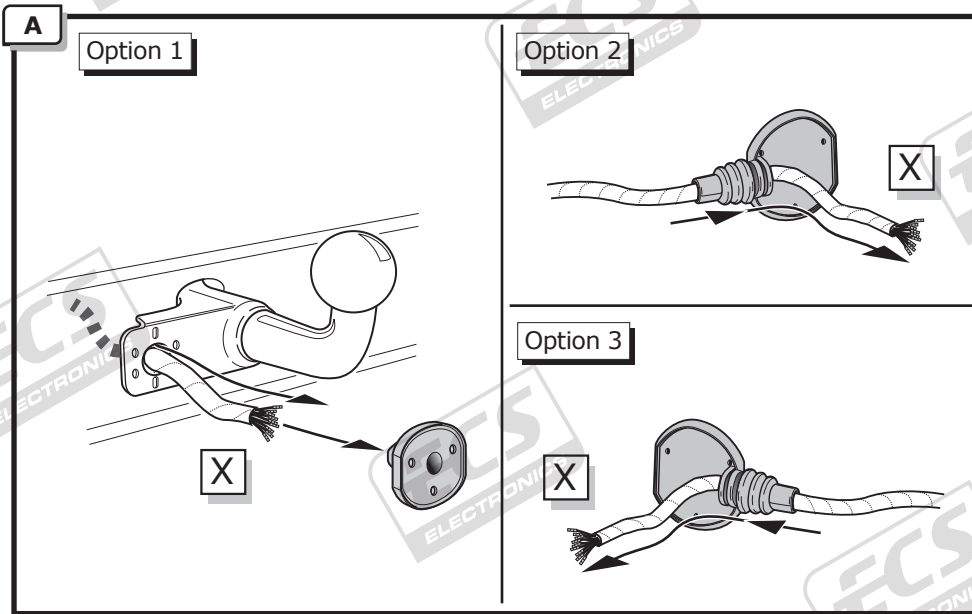

**INFO**

- ⒹE Anschluss Steckdose
- ⒻFR Connection de la prise
- ⒶNL Contactdoos aansluiting
- ⒼGB Socket connection
- ⒺES Conexión de la caja de enchufe
- ⒾIT Allaccio zoccolo
- ⒺSE Anslutning kontaktdosa
- ⒸZ Objímkový konektor
- ⒹK Stikdåse forbindelse
- ⒻFI Pistorasia liitäntä
- ⒼGR Υποδοχή σύνδεσης
- ⒶNO Tilkobling koblingsboks
- ⒶPL Połączenie przez gniazdo

 **Pag. 20**

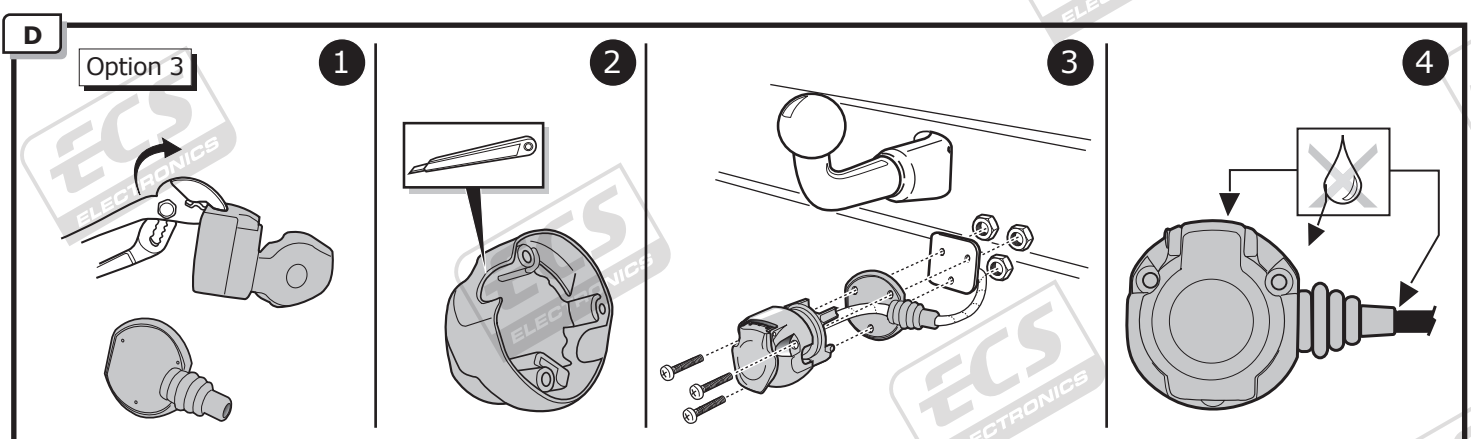
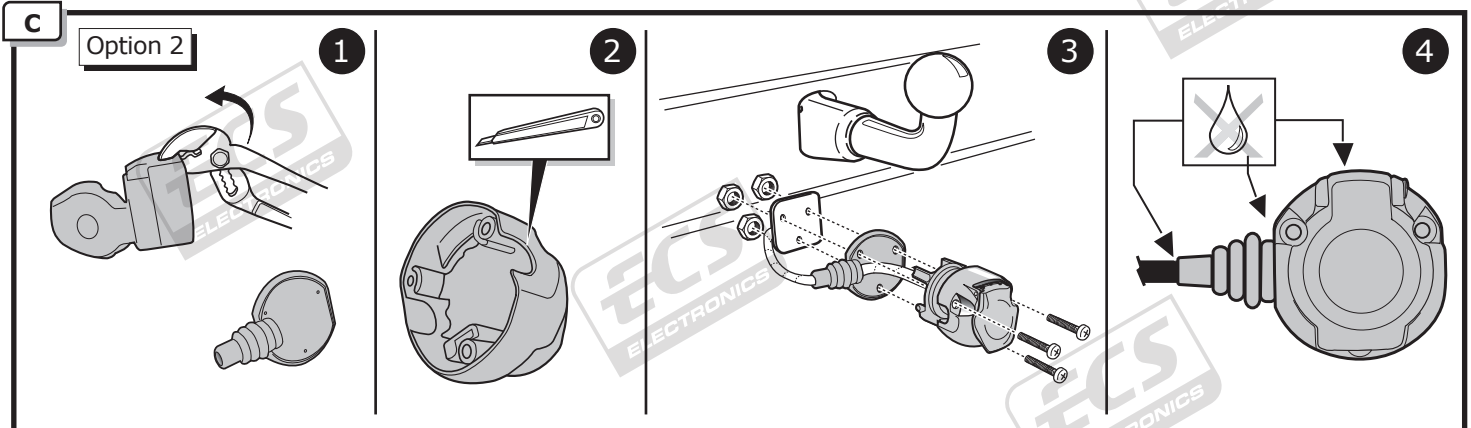
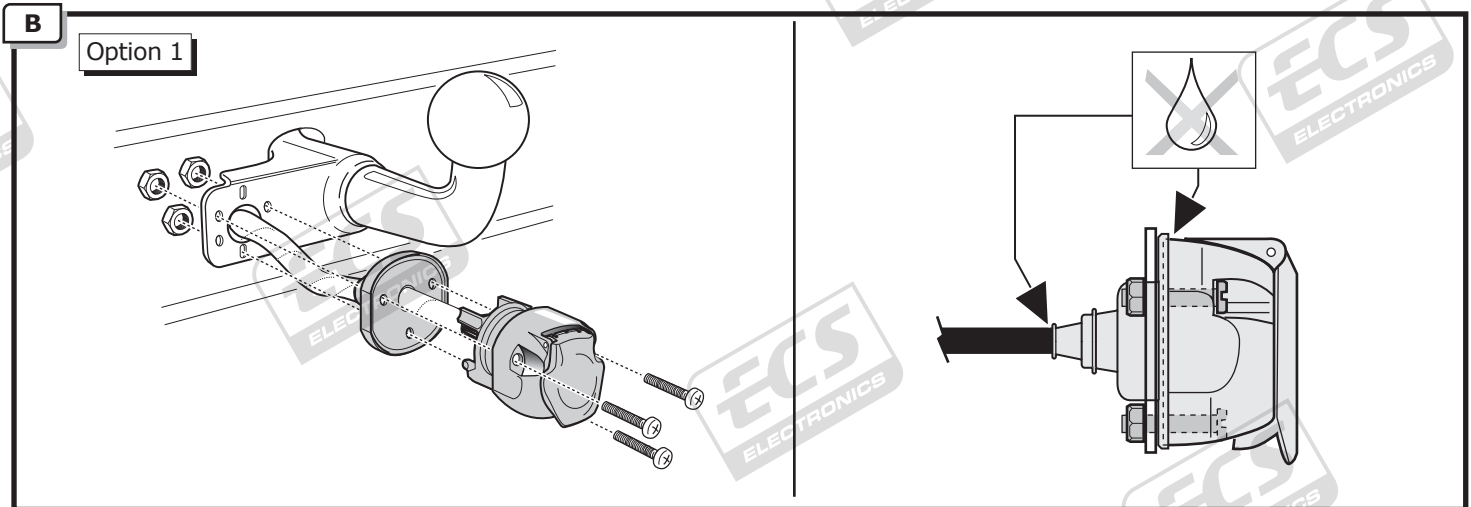

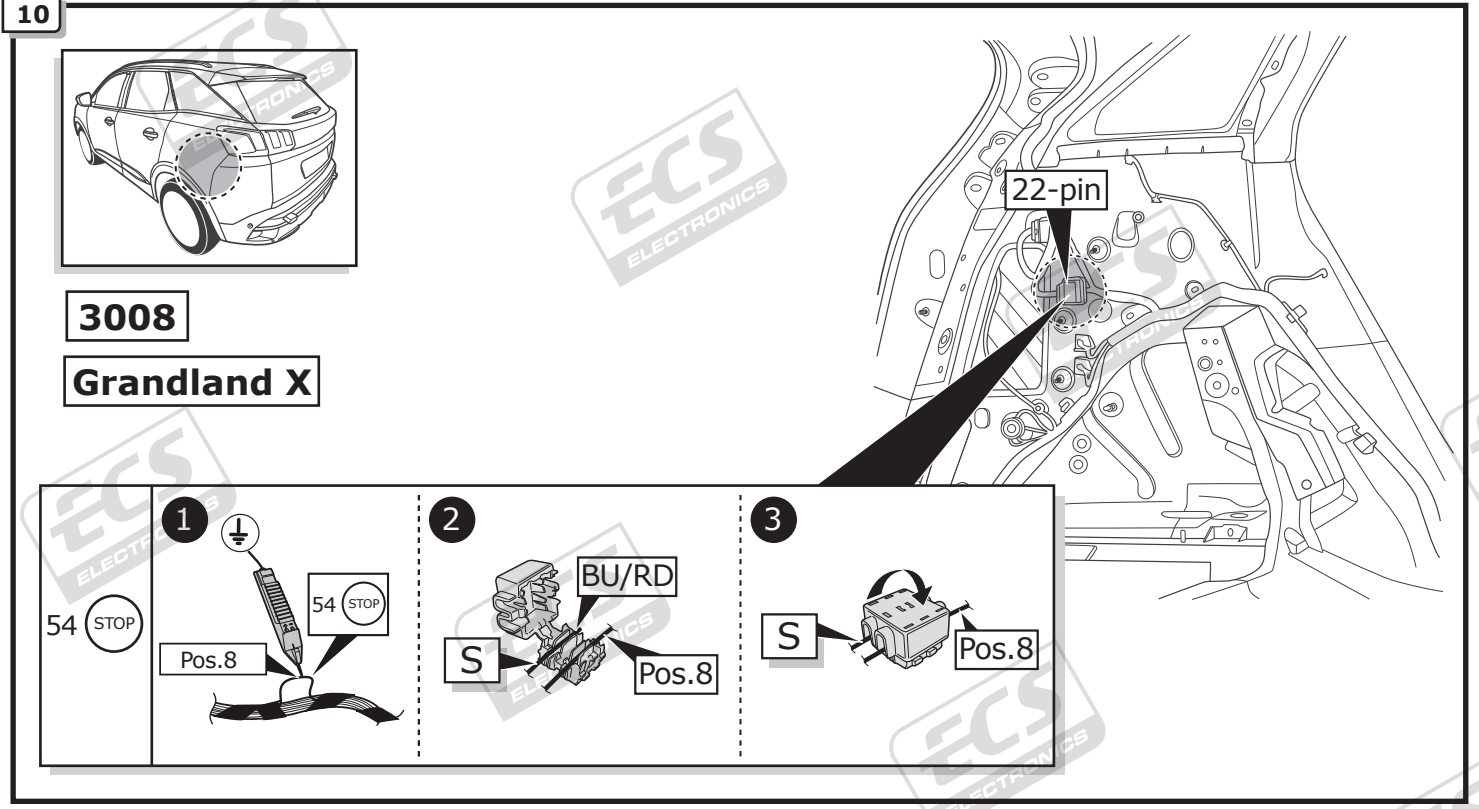
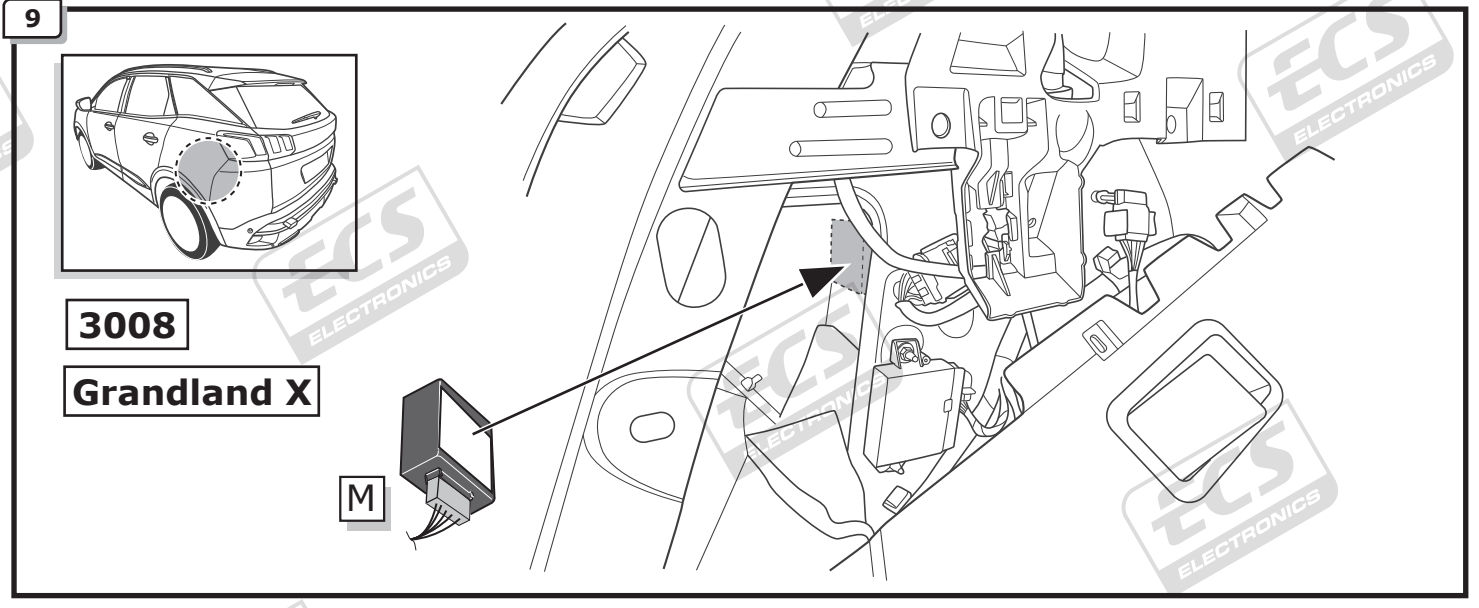
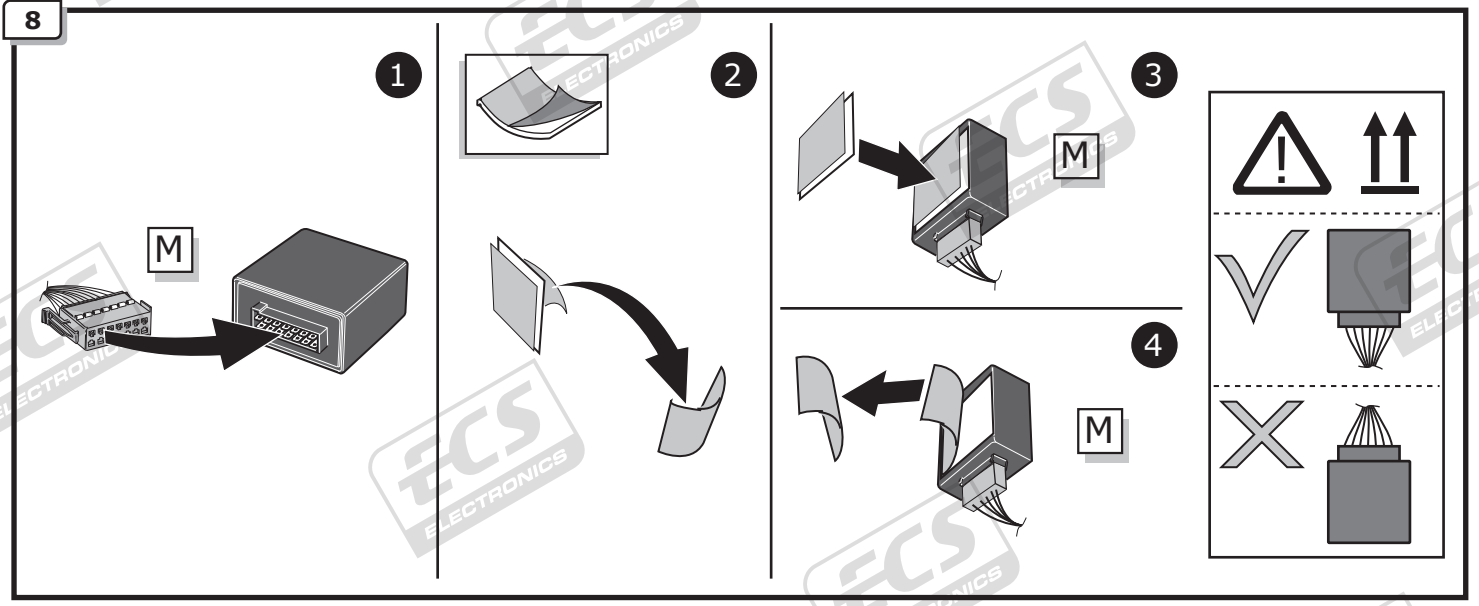



11

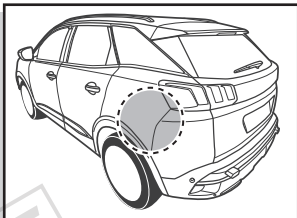

3008

Grandland X

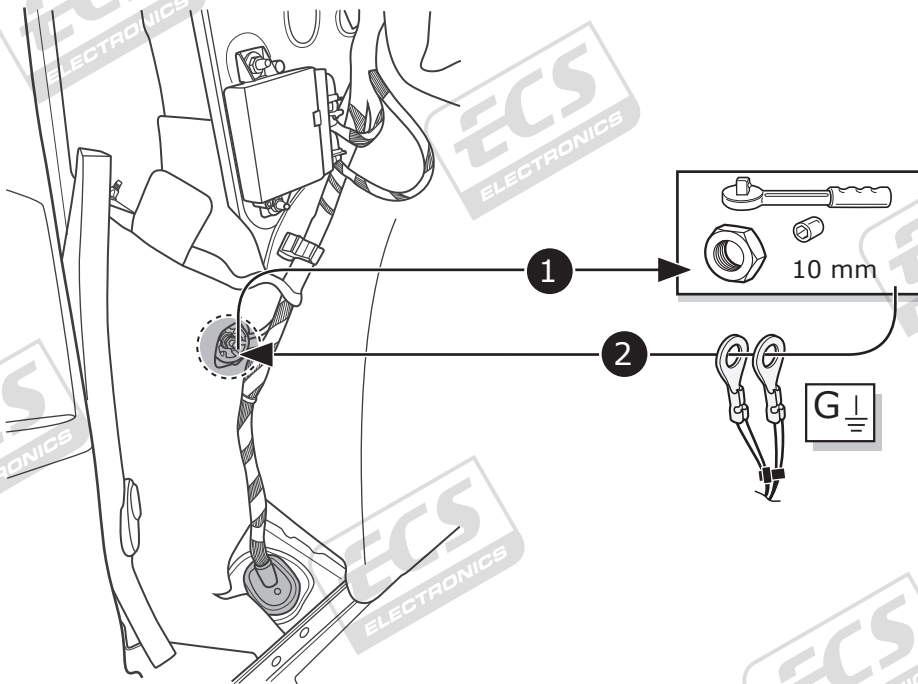

12

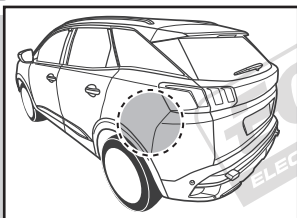

DS7 Crossback

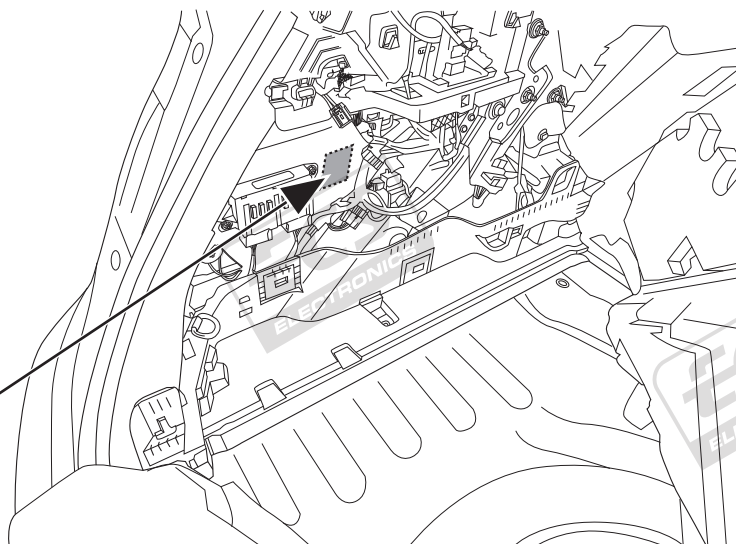
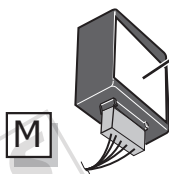

13

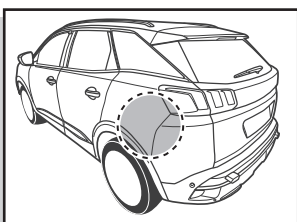

DS7 Crossback

22-pin

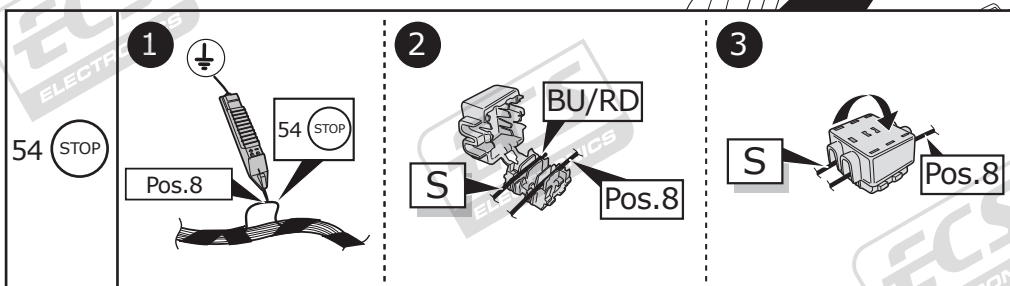
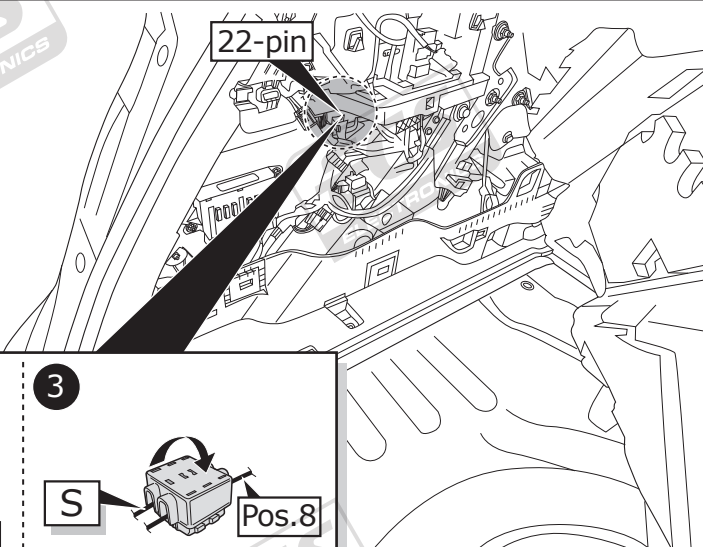

14

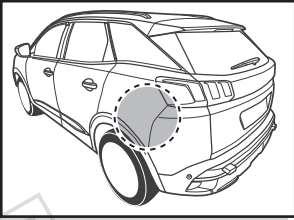

**DS7 Crossback**

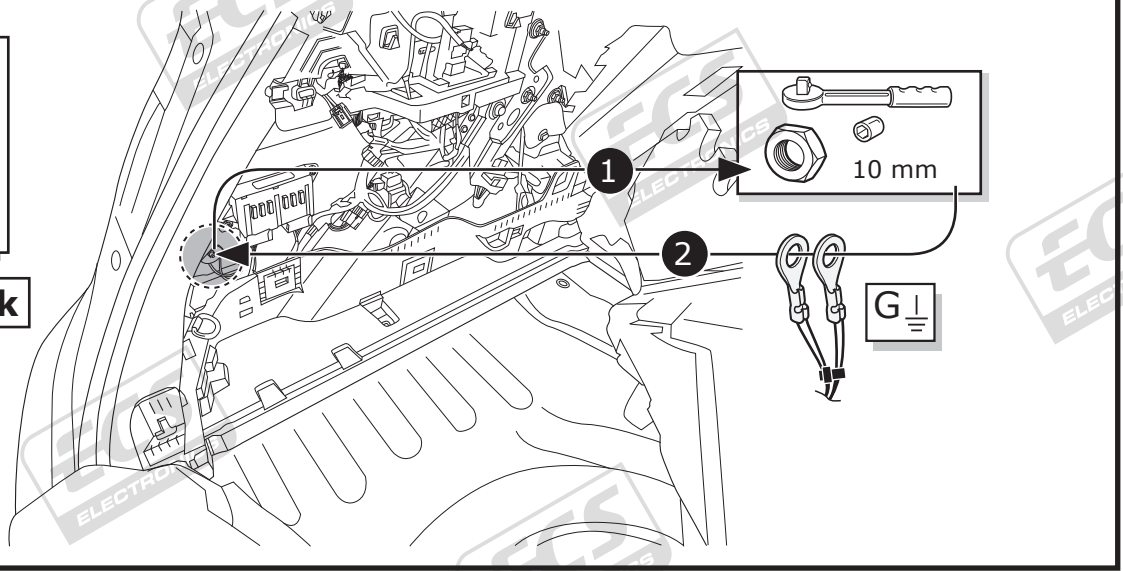

15

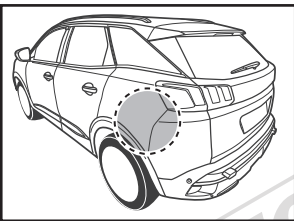

**DS7 Crossback**

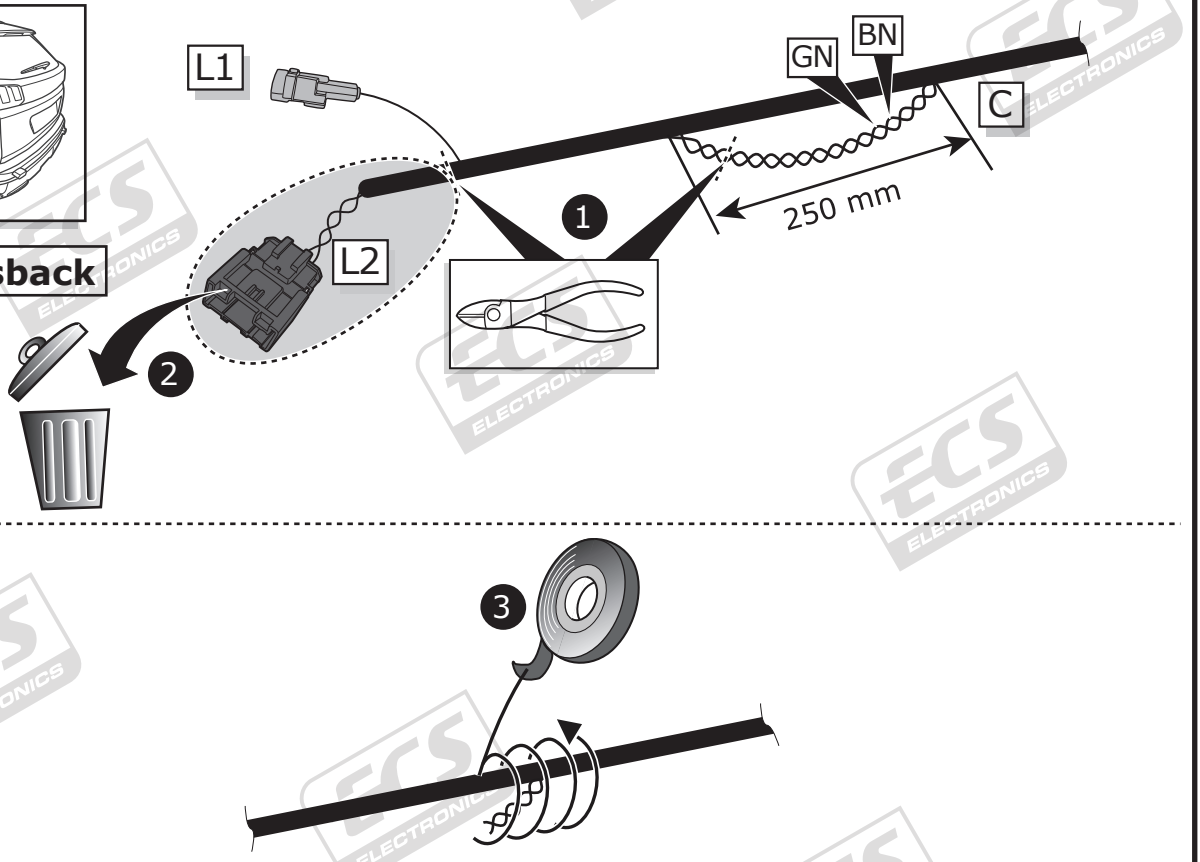

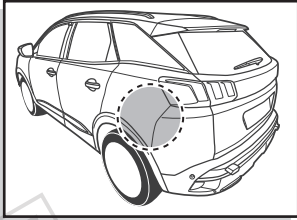

**DS7 Crossback**

**CAN-Data Wire**

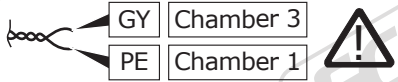

**Wichtig!**  
**Unbedingt Hinweise**  
**aus Bild 1 beachten!**  
**Important!**  
**Please note**  
**informations in**  
**picture 1!**

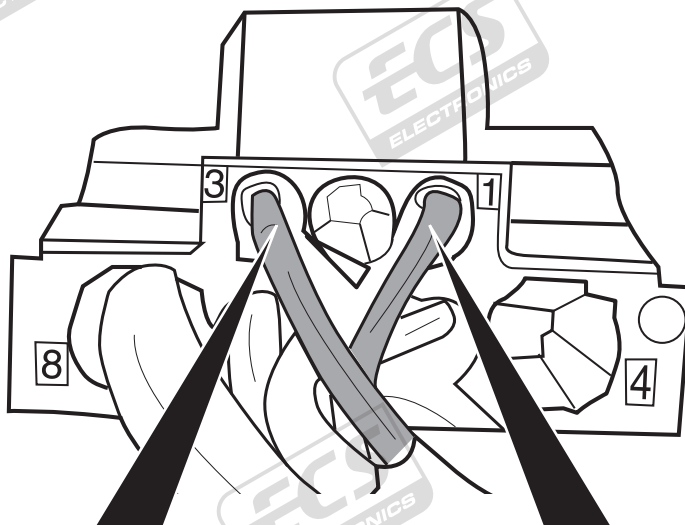
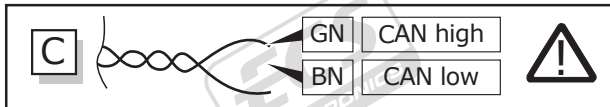
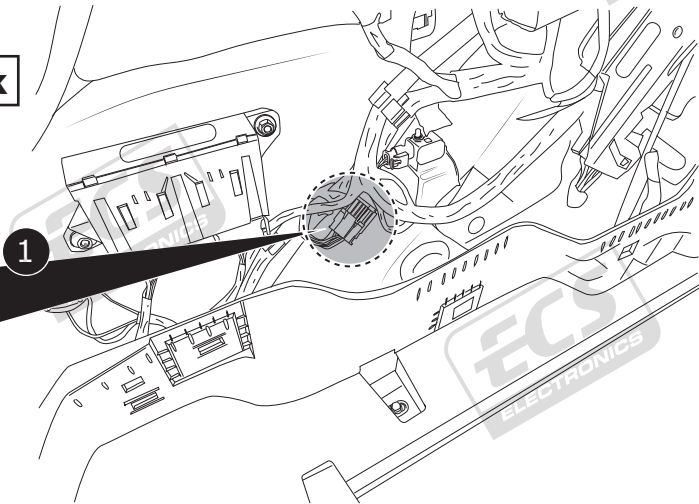
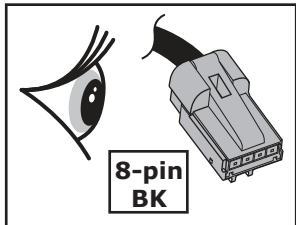

**2**

BN CAN low

GY Chamber 3

**3**

GY Chamber 3

**4**

**5**

GN CAN high

PE Chamber 1

**6**

PE Chamber 1

**7**

**3**

GY Chamber 3

**4**

**5**

GN CAN high

PE Chamber 1

**6**

PE Chamber 1

**7**

17

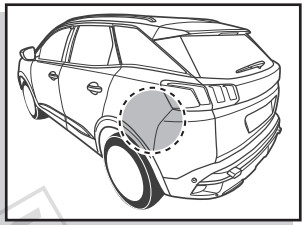

**5008**  
**C5 Aircross**

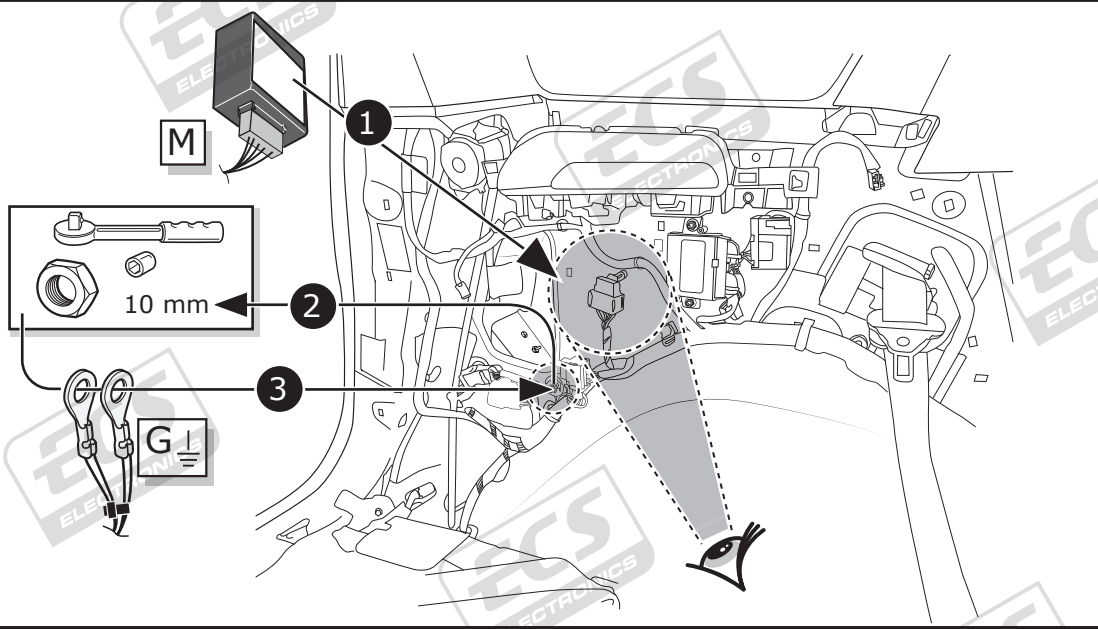

18

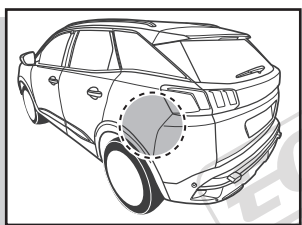

**5008**

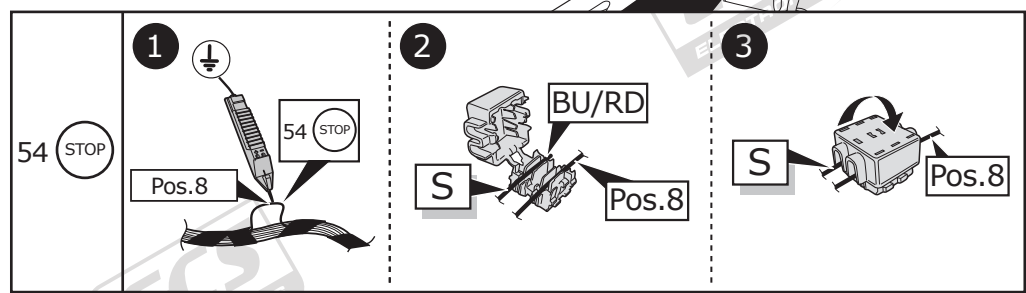
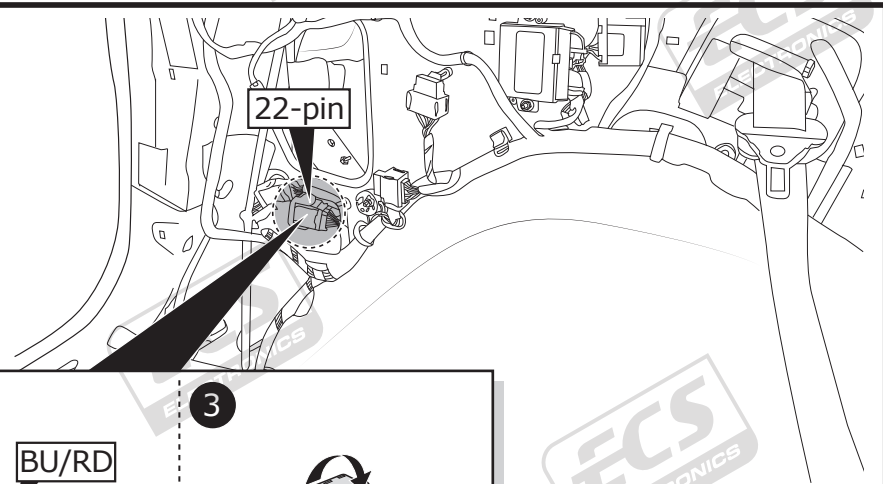

19

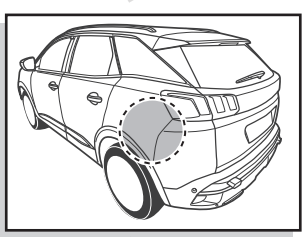

**C5 Aircross**

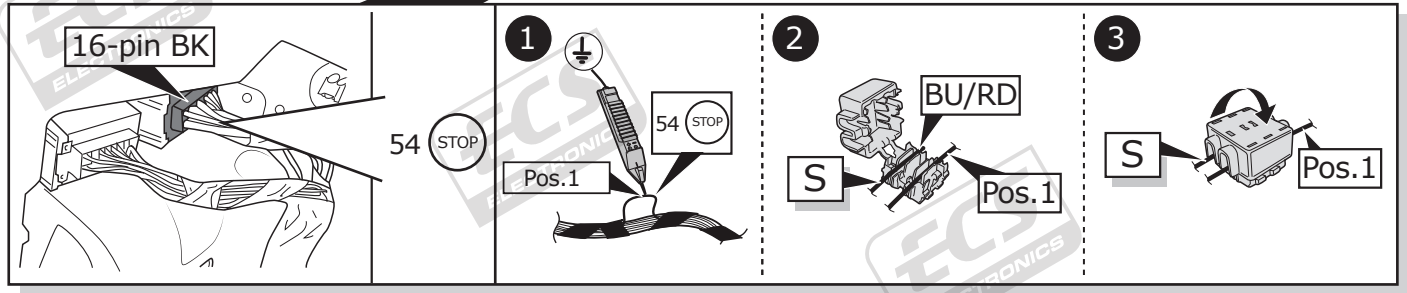
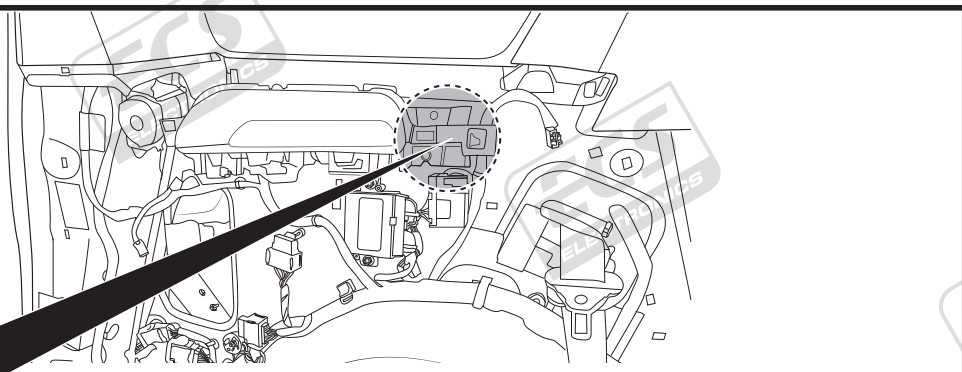

3008

5008

C5 Aircross

Grandland X

DS7 Crossback

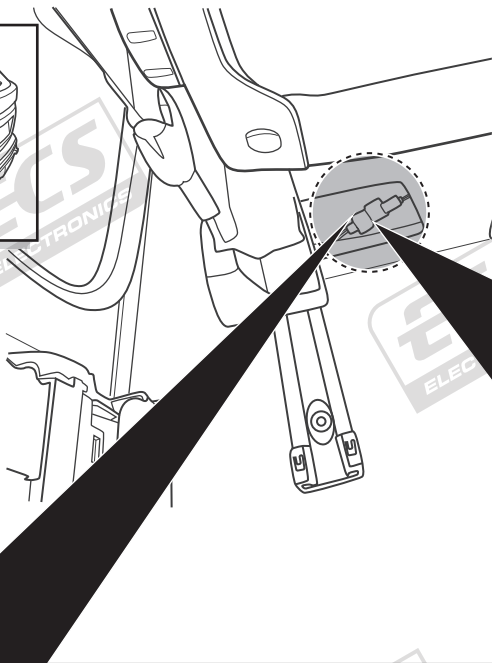
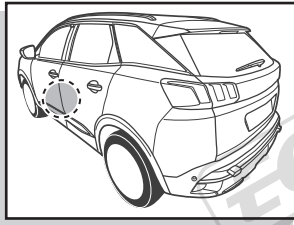
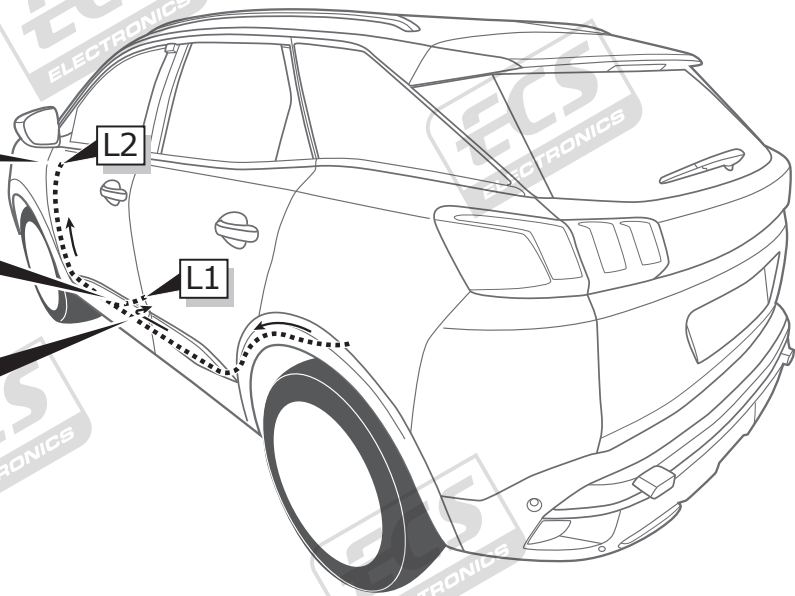

Option 1

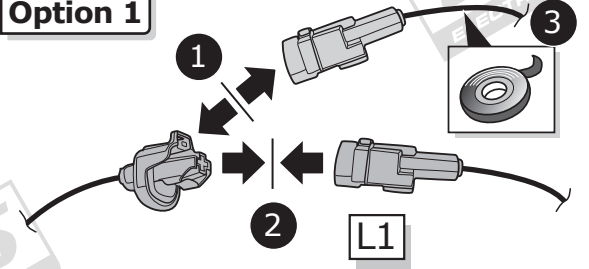

Option 2

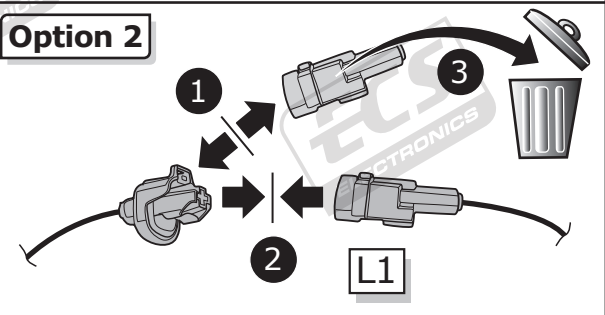

Option 3

Only Grandland X

BK  
1-pin

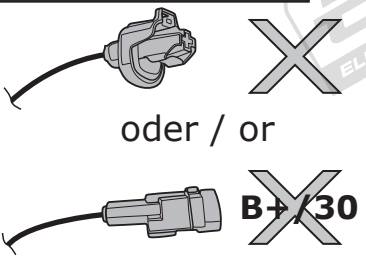

1

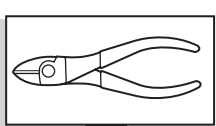

B+/30

RD

L1



2

RD  
L1

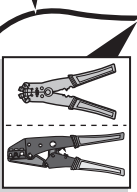

3

RD  
L1



B+/30

RD

U1



24

22

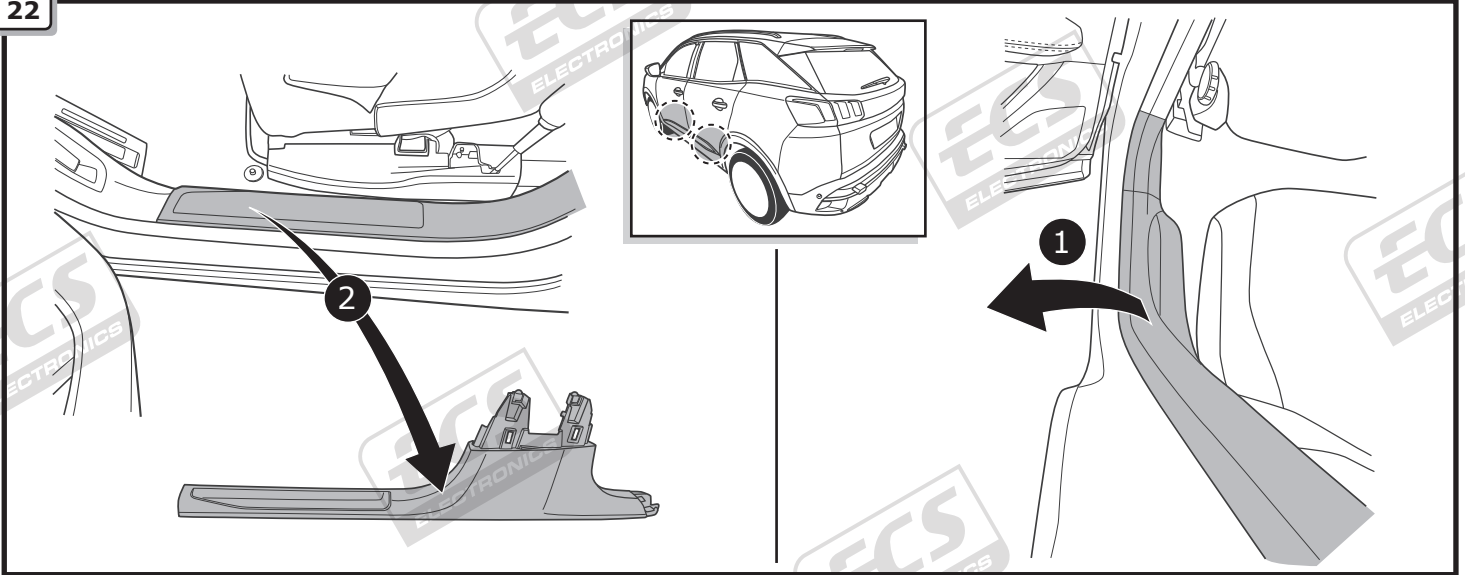

23

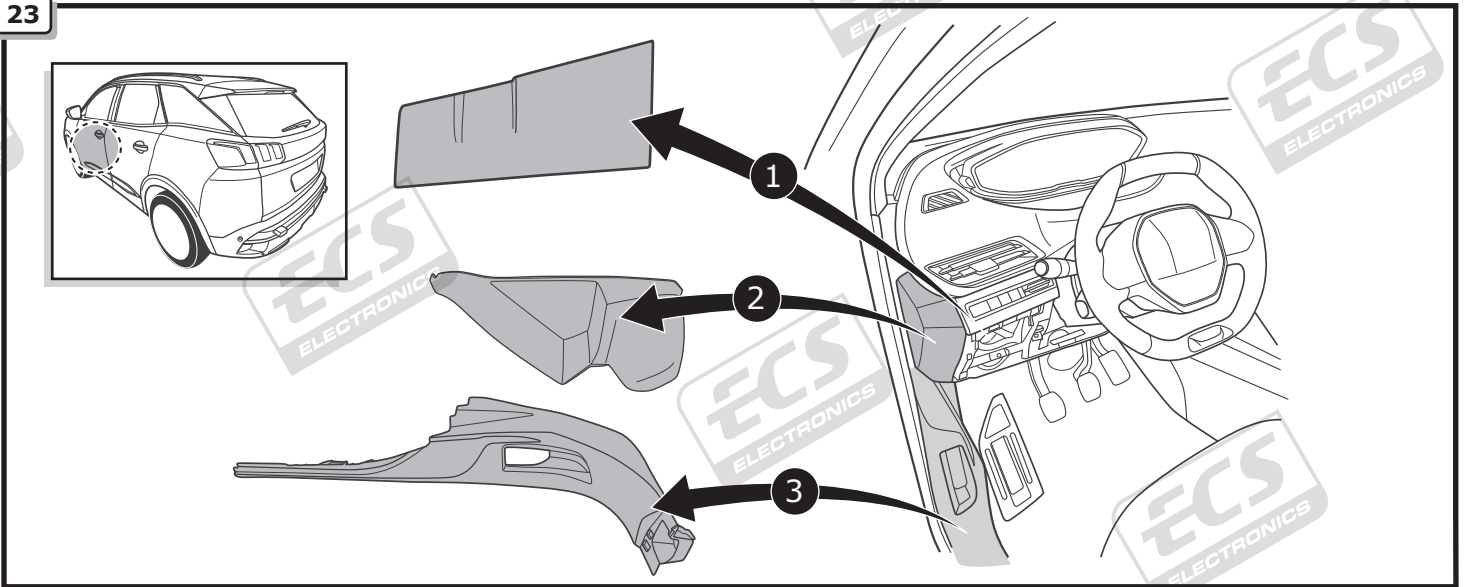

24

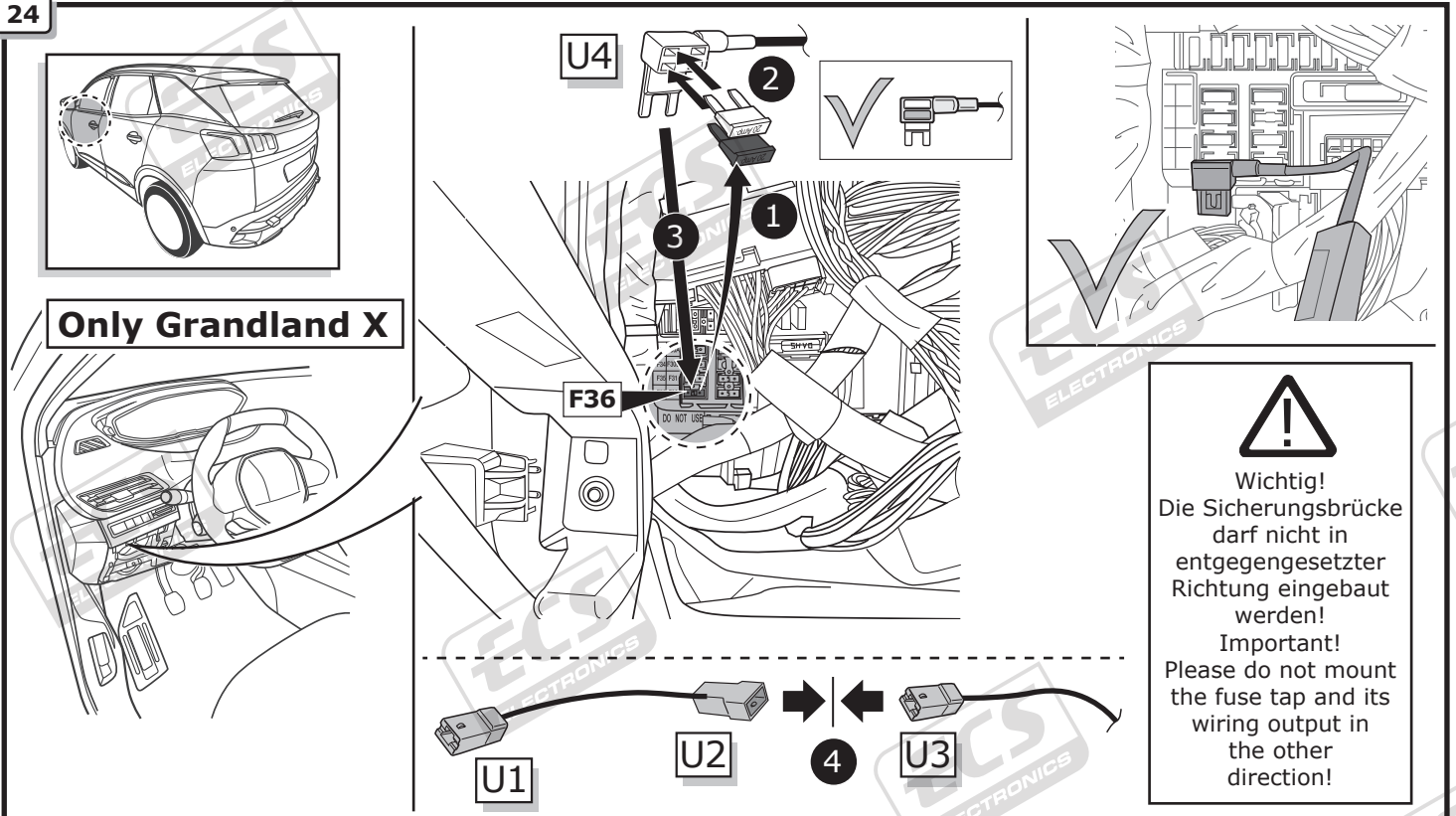

25

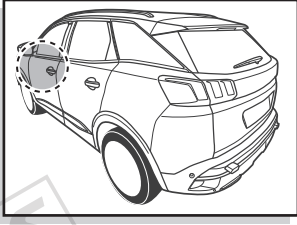

3008

5008

C5 Aircross

Grandland X

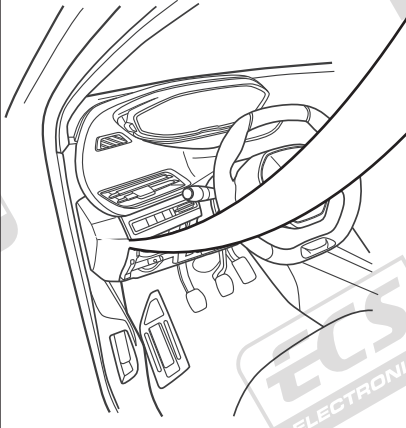

Option 1

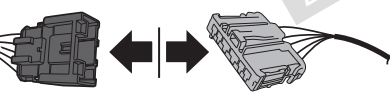

Option 2

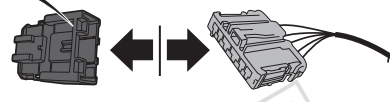

L2

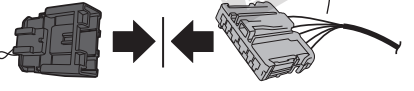

26

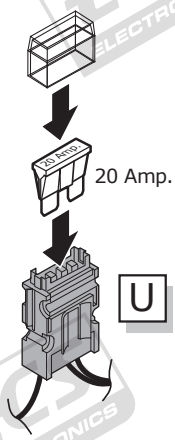

20 Amp.

U

27

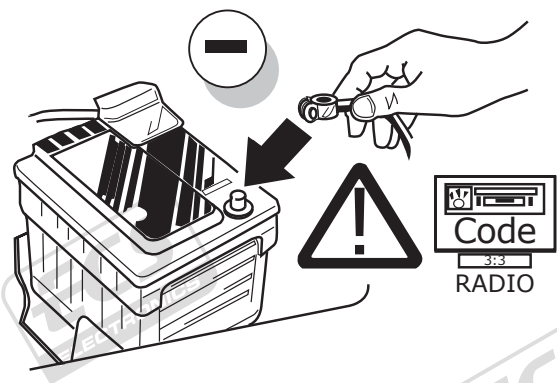

Code  
333  
RADIO

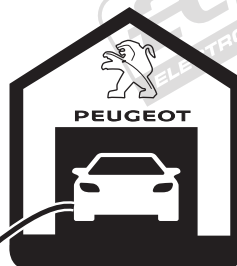
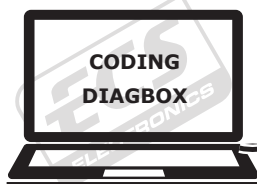
**CITROËN****C5 Aircross****DS****DS7 Crossback****PEUGEOT****3008****5008**

DE

GB

FR

**Die Aktivierung der Anhängerfunktionen**

**muss mit Hilfe der CITROËN/PEUGEOT DIAGBOX wie folgt durchgeführt werden:**

- Fahrzeug auswählen
- Auslieferung
- Ausstattungen
- Schalteinheit Anhänger (BSR)
- Installation einer Ausstattung

**The activation of the trailer functions**

**has to be carried out using the CITROËN/PEUGEOT DIAGBOX as follows:**

- choose vehicle
- delivery
- equipment
- trailer control unit (BSR)
- installation of equipment

**L'activation des fonctions de la remorque**

**doit être effectuée comme suit à l'aide du testeur DIAGBOX CITROËN/PEUGEOT:**

- choisir des véhicules
- livraison
- équipements
- partie commutation - remorque (BSR)
- installation d'un équipement

IT

ES

NL

**L'attivazione di rimorchio funzioni**

**si deve eseguire con l'aiuto del tester CITROËN/PEUGEOT DIAGBOX come segue:**

- Scegliere veicolo
- I tempi di consegna
- Attrezzature
- Centralina rimorchio (BSR)
- L'installazione di apparecchiature

**La activación del funciones de remolque**

**• deberá llevarse a cabo con ayuda del comprobador de CITROËN/PEUGEOT DIAGBOX de la siguiente manera:**

- elegir vehículo
- entrega
- equipo
- unidad de conmutación - remolque (BSR)
- instalación de equipos i

**De activering van de trailer-functies**

**moet met behulp van de CITROËN/PEUGEOT DIAGBOX als volgt worden uitgevoerd:**

- Kies het voertuig
- Levering
- Apparatuur
- Schakelunit aanhanger (BSR)
- Installatie van apparatuur



OPEL

Grandland X

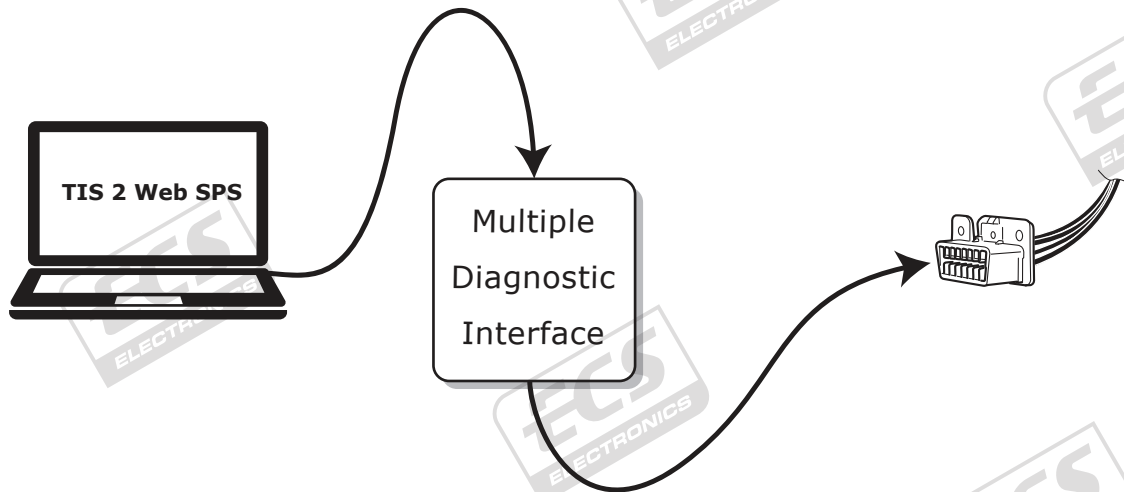
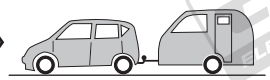

(DE)

(GB)

(FR)

**Die Aktivierung der Anhängerfunktionen**

**muss mit Hilfe des OPEL TIS 2 WEB SPS wie folgt durchgeführt werden:**

- Fahrzeug auswählen
- Z6 Fahrzeugoptionen ändern
  - > Anhängerzugvorrichtung hinzufügen
  - > Normal
- Installation starten

**The activation of the trailer functions**

**has to be carried out using the OPEL TIS 2 WEB SPS as follows:**

- choose vehicle
- Z6 change vehicle options
  - > add Trailer Hitch
  - > normal
- start installation

**L'activation des fonctions de la remorque**

**doit être effectuée comme suit à l'aide du testeur OPEL TIS 2 WEB SPS:**

- choisir des véhicules
- Z6 modifier les options du véhicule
  - > ajouter remorque
  - > normalement
- commencer l'installation

(IT)

(ES)

(NL)

**L'attivazione di rimorchio funzioni**

**si deve eseguire con l'aiuto del tester OPEL TIS 2 WEB SPS come segue:**

- Scegliere veicolo
- Z6 cambia le opzioni del veicolo
  - > aggiungere rimorchio
  - > normalmente
- avvia l'installazione

**La activación del funciones de remorque**

**deberá llevarse a cabo con ayuda del comprobador de OPEL TIS 2 WEB SPS de la siguiente manera:**

- elegir vehículo
- Z6 cambiar las opciones del vehículo
  - > añadir remorque
  - > normalmente
- comenzar la instalación

**De activering van de trailer-functies**

**moet met behulp van de OPEL TIS 2 WEB SPS als volgt worden uitgevoerd:**

- Kies het voertuig
- Z6 verander voertuigopties
  - > aanhanger toevoegen
  - > normaal
- start de installatie

30

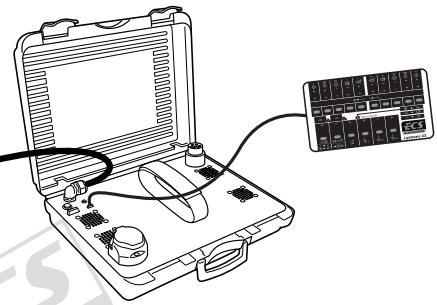
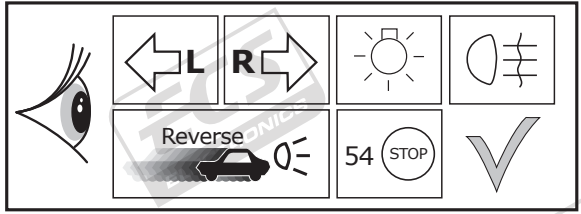
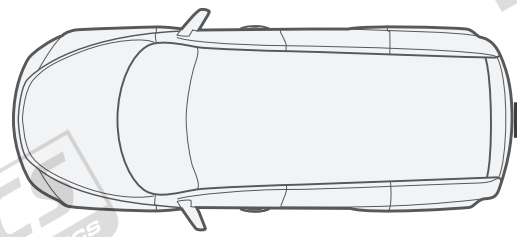

31

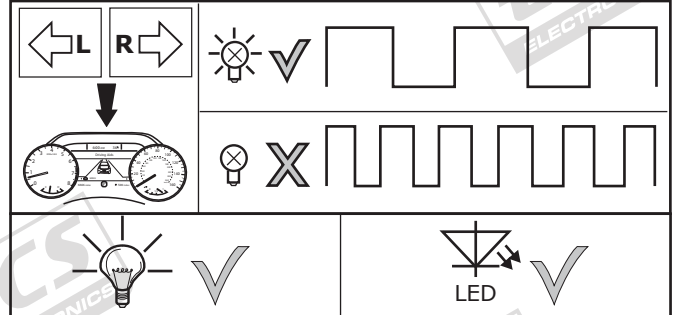
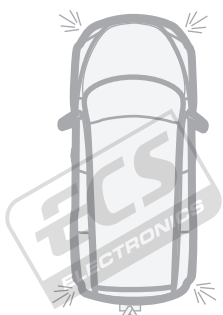

32

Optional

Adapter socket

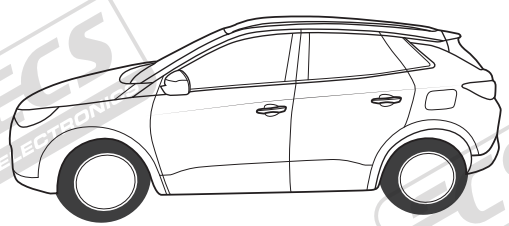

13-pin

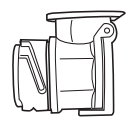

7-pin

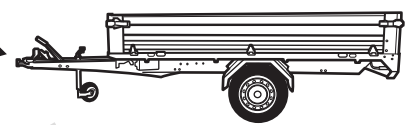

33

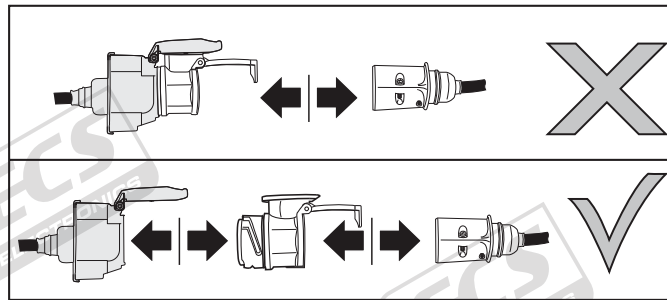
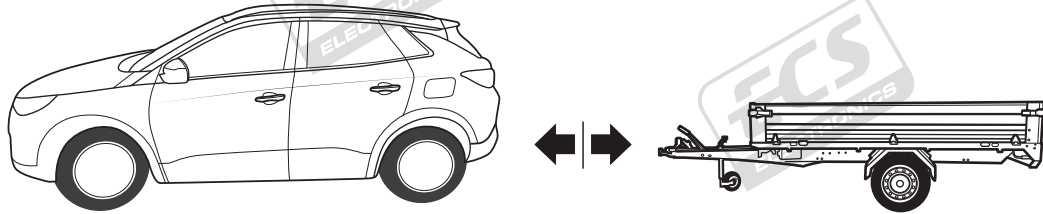

34

- DE Einzelteile wieder einbauen
- FR Remonter les pièces démontées
- NL Terug plaatsen onderdelen
- GB Reinstall linings
- ES Reinstalar componentes
- IT Rimetti a posto componenti
- SE Sätt tillbaka delar
- CZ Znovu zasuňte obložení
- DK Påsæt beklædningen
- FI Asenna verhoilit takaisin
- GR Τοποθετήστε ξανά τις επενδύσεις
- NO Sett tilbake deler
- PL Założyć wykładzinę

35

- DE Gebrauchsanleitung.
- FR Mode d'emploi.
- NL Gebruikershandleiding.
- GB User guide.
- ES Guía del usuario.
- IT Manuale di istruzioni.
- SE Bruksanvisning.
- CZ Uživatelská příručka.
- DK Brugervejledning.
- FI Käyttöohjeet.
- GR Οδηγός χρήστη.
- NO Brukerveiledning.
- PL Instrukcja obsługi.

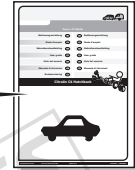
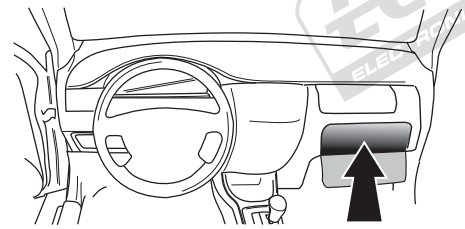

36



## Products & Service

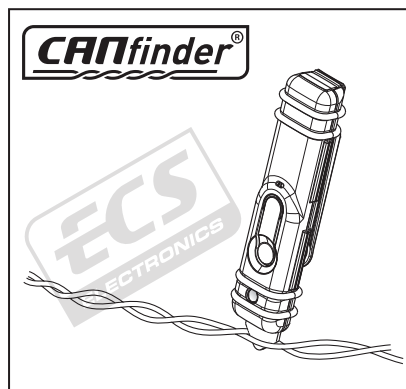

## LIGHT MATE



[http://www.ecs-electronics.nl/NL/catalogus/test\\_gereedschap](http://www.ecs-electronics.nl/NL/catalogus/test_gereedschap)

(DE) Anschluss Steckdose  
 (FR) Connection de la prise  
 (NL) Contactdoos aansluiting  
 (GB) Socket connection

(ES) Conexión de la caja de enchufe  
 (IT) Allaccio zoccolo  
 (SE) Anslutning kontaktdosa

(CZ) Objímkový konektor  
 (DK) Stikdåse forbindelse  
 (FI) Pistorasia liitäntä

(GR) Υποδοχή σύνδεσης  
 (NO) Tilkobling koblingsboks  
 (PL) Połączenie przez gniazdo

DIN/ISO 11446														
Pmax	1/L 21W	2 21W	3/31 21W	4/R 21W	5/58-R 42W	6/54 3x21W	7/58-L 42W	8 21W	9 180W/15Amp.	10 180W/15Amp.	11	12	13	
(DE)	Gelb	Blau	Weiß	Grün	Braun	Rot	Schwarz	Rosa	Orange	Grau	Weiß/ Schwarz	-	Weiß/ Rot	
(FR)	Jaune	Bleu	Blanc	Vert	Marron	Rouge	Noir	Rose	Orange	Gris	Blanc/ Noir	-	Blanc/ Rouge	
(NL)	Geel	Blauw	Wit	Groen	Bruin	Rood	Zwart	Roze	Oranje	Grijs	Wit/ Zwart	-	Wit/ Rood	
(GB)	Yellow	Blue	White	Green	Brown	Red	Black	Pink	Orange	Grey	White/ Black	-	White/ Red	
(ES)	Amarillo	Azul	Blanco	Verde	Marrón	Rojo	Negro	Rosa	Naranja	Gris	Blanco/ Negro	-	Blanco/ Rojo	
(IT)	Giallo	Blu	Bianco	Verde	Marrone	Rosso	Nero	Rosa	Arancione	Grigio	Bianco/ Nero	-	Bianco/ Rosso	
(SE)	Gul	Blä	Vit	Grön	Brun	Röd	Svart	Rosa	Orange	Grå	Vit/ Svart	-	Vit/ Röd	
(CZ)	Žlutá	Modrá	Bílá	Zelená	Hnědá	Červená	Černá	Růžová	Oranžová	Šedá	Bílá/ Černá	-	Bílá/ Červená	
(DK)	Gul	Bla	Hvid	Grøn	Brun	Rød	Sort	Pink	Orange	Grå	Hvid/ Sort	-	Hvid/ Rød	
(FI)	Keltainen	Sininen	Valkoinen	Vihreä	Ruskea	Punainen	Musta	Vaaleanpunainen	Oranssi	Hamaa	Valkoinen/ Musta	-	Valkoinen/ Punainen	
(GR)	Κίτρινο	Μπλε	Λευκό	Πράσινο	Καφέ	Κόκκινο	Μαύρο	Ροζ	Πορτοκαλί	Γκρι	Λευκό/ Μαύρο	-	Λευκό/ Κόκκινο	
(NO)	Gul	Bla	Hvit	Grønn	Brun	Rød	Svart	Rosa	Oransje	Grå	Hvit/ Svart	-	Hvit/ Rød	
(PL)	Żółty	Niebieski	Biały	Zielony	Brązowy	Czerwonony	Czarny	Różowy	Pomarańczowy	Szary	Biały/ Czarny	-	Biały/ Czerwonony	